

2018



# Steel Lintel Manual



Keystone produces more than just steel lintels. Our specialist product range is designed to meet the needs of even the most complex project.

---

## HI-THERM+

Keystone has redefined lintel performance with Hi-therm+ the low cost solution to reduced Carbon Emissions and improved Fabric Energy Efficiency.

---

## STANDARD LINTELS

Keystone produces a wide range of standard galvanised steel lintels. All Keystone standard lintels satisfy the Thermal Performance requirements of all UK building regulations.

---

## STAINLESS STEEL

Keystone's full range of lintels is also available in stainless steel, providing the same high quality and performance features as our standard galvanised lintels.

---

## SPECIAL LINTELS

Keystone offers a complete custom design service to ensure your project has the best lintel for the job. Our technical expertise is renowned for value engineering the optimum solution.

---

## BRICK SLIP FEATURE LINTELS

Keystone Brick Slip Feature Lintels are a one piece, prefabricated unit with factory applied brick slips. Units are manufactured bespoke to order and can achieve even the most challenging architectural designs.

---

## MASONRY SUPPORT & WINDPOST SYSTEMS

Keystone continues to set the standard for masonry support and windpost systems for a range of building frame configurations. The innovative Keystone Masonry Support System provides a versatile solution when masonry support is required.

---

## CAVITY TRAYS

The Keystone Cavity Tray presents a lightweight, simple to install and long lasting solution to preventing dampness from penetrating below the roof line.

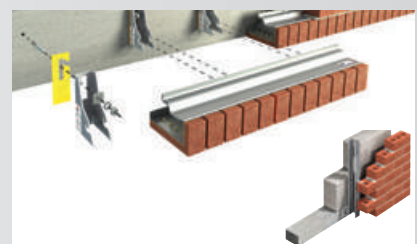
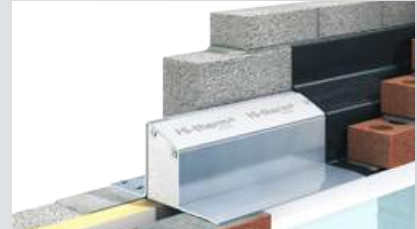

# Steel Lintel Manual

## CONTENTS

	PAGE		PAGE
Range	<b>2</b>	7 Timber Frame Lintels	<b>40</b>
Service	<b>4</b>	8 Single Leaf Lintels	<b>43</b>
Performance	<b>5</b>	9 Box Lintels	<b>44</b>
Lintel Installation	<b>6</b>	10 Solid Wall Lintels	<b>48</b>
Selecting a lintel	<b>7</b>	11 Extended Range	<b>50</b>
Lintel Range Index	<b>8</b>	12 Stainless Steel Range	<b>53</b>
1 Hi-therm+	<b>10</b>	Special Lintels	<b>54</b>
2 Cavity wall 100mm inner leaf	<b>12</b>	Sun Lounge Lintels	<b>60</b>
3 Cavity wall wide inner leaf	<b>19</b>	Brick Slip Feature Lintels	<b>66</b>
4 Cavity wall wide outer leaf	<b>29</b>	Masonry Support Systems	<b>72</b>
5 Eaves Lintels	<b>37</b>	Windposts	<b>74</b>
6 Porotherm Lintels	<b>38</b>	Signature Projects	<b>76</b>
		Cavity Trays	<b>83</b>



BBA Certification



Home Builders  
Federation

**NHBC**

National Building  
Specification Approved



Builders Merchants  
Federation



British Standards  
Institution  
ISO 9001 & ISO 14001

**bre**

Building Research  
Establishment



RIBA CPD  
Approved



Compliance with  
EU legislation



Investors in People  
Accreditation





Keystone Lintels gives a hassle free service from enquiry stage through to delivery on site. You can relax in the knowledge that your order is in the hands of experts.

## Service



4

### TECHNICAL SUPPORT

Keystone provides comprehensive technical support for all products. Our free scheduling and specification service offers fast turnaround on standard lintels, masonry support and windpost systems.

Keystone leads the market with a bespoke design service for special lintels and brick slip feature lintels, including onsite measurement and technical assistance.

Our in-house experts use the latest thermal modelling software to advise clients on the optimum lintel solution for compliance with and beyond the latest building regulations.

By contacting our engineers at an early stage of your design process, you will potentially gain significantly more design flexibility for the overall project. Please contact your local Keystone technical office.

Please refer to our Fax Back Forms for special lintel requirements. Detailed measuring advice and Fax Back Enquiry Forms are available to download at: [www.keystonelintels.com/technical](http://www.keystonelintels.com/technical).

### FASTRACK DATABASE FOR CAD

The Keystone Fastrack Database is accessible from the Keystone website and provides downloads of CAD files for a selection of Keystone Steel Lintels.

### DELIVERY

Keystone's fast, efficient delivery service is renowned throughout the construction industry. Our logistics solution is recognised by our customers for superior supply chain management.

Keystone continues to provide the largest range of lintels available, with the shortest lead times in the industry. We have invested in large stock inventories at our two manufacturing and distribution centres reassuring our customers that all our standard lintels are instantly available upon request.

Keystone has revolutionised the steel lintel industry by manufacturing and delivering 'special' lintels with lead-times historically associated with ex-stock items.

Keystone products are available through a national network of merchant suppliers.

# Performance

## STANDARD KEYSTONE LINTEL

with patented Thermal Break Plate

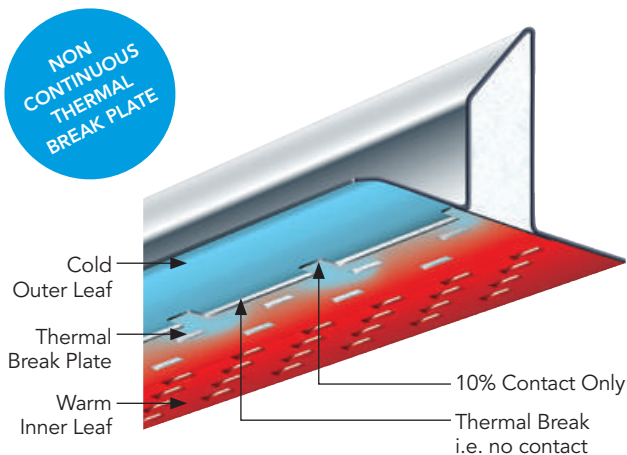

Standard Keystone Lintel with patented non continuous Thermal Break Plate



All Keystone standard lintels satisfy the thermal performance requirements of England and Wales' Part L of the building regulations, Northern Ireland's Part F and Scotland's Technical Handbook, section 6.

### FIRE PERFORMANCE

Keystone lintels have been subjected to a fire test (ref: WARRES No.101263) in accordance with BS 476: Part20: 1987, at Exova Warringtonfire and achieved a one hour fire performance.

### GALVANISED STEEL

Keystone's standard range of lintels are manufactured from high quality grade pre-galvanised mild steel to BS EN 10346:2009 DX51D plus Z600 or grade Z275 to BS EN10025-2:2004 with minimised spangle finish and a minimum yield stress of 250N/mm<sup>2</sup>.

### STAINLESS STEEL

Please refer to page 53 for details.

### STRUCTURAL PERFORMANCE

The Keystone Lintel range has safe working loads as detailed in each applicable loading table in our Lintel Range and Loading tables, pages 11-53. The structural performance figures within each table have been ascertained by testing in accordance with the requirements of standards BS 5977 Part 2: 1983 and BS EN 845-2:2003.

The figures take into account the different loading arrangements which are common to traditional cavity wall construction.

Differential Total UDL kN 3:1  
Up to 75% loading on the inner leaf.

Differential Total UDL kN 19:1  
Up to 95% loading on the inner leaf.

### LINTEL LOAD TABLES

For full details of load tables specific to your lintel type please see Lintel Range & Loading Tables pages 11-53.

**Differential Load 3:1 ratio, 75% load on inner leaf.**  
**Differential Load 19:1 ratio, 95% load on inner leaf.**

Lintel types: HD/K, S/K-50 (215WIL), S/K-70 (215WIL), S/K-90 (215WIL), S/K-110, S/K-130, S/K-150, SB/K, T/K, SL/K, RB/K, TJ/K, TW/K, INT/K, SW/K, IB/K, EL/K-50, EL/K-90, CFS/K, X/K have been tested as a composite unit with surrounding masonry, built in accordance with BS EN 1996-2:2006. These composite units have been tested in accordance with the requirements of BS5977: part 2: 1983 (BS EN 845-2:2003).

### LINTEL LIFE SPAN

The Keystone lintel range complies with the technical requirements of the BLP (Building Life Plans) regarding the durability data of mild steel, cold formed lintels.

### POLYSTYRENE INSULATION

Keystone lintels are insulated with expanded CFC free polystyrene and conform to BS 13163: 2008.



# Lintel Installation

- 1 Lintels should be installed with a minimum end bearing of 150mm, bedded on mortar and levelled along its length and across its width.
- 2 The masonry above the lintel should be built in accordance with BS EN 1996-2:2006.
- 3 Raise the inner and outer leaves simultaneously to avoid excessive eccentricity of loading, with a maximum height difference of 225mm (masonry should be laid on a mortar bed and all perpendicular joints should be filled).
- 4 Allow the mortar to cure before applying floor or roof loads (Temporary propping beneath a steel lintel is practised to facilitate speed of construction).
- 5 The NHBC recommend a damp proof course (DPC) or cavity tray should be installed over all openings in external cavity walls.
- 6 When installing concrete floor units or other heavy components above a lintel, care should be taken to avoid shock loading and floor units should not be dragged into position. Masonry immediately above the lintel should be allowed to cure.
- 7 Point loads should not be applied directly onto lintel flanges. Lintels should have a minimum of 150mm masonry between the flange and the application level of any form of loading. Consult Keystone's technical department if applying a point load above a lintel.
- 8 The external lintel flange must project beyond the window/door frame and it is recommended that a flexible sealing compound is used between the underside of the lintel flange and the frame.
- 9 When the underside of a lintel is exposed, its appearance can be enhanced by the addition of lintel soffit cladding.
- 10 Do not cut lintels to length or modify them in any way without consulting a Keystone engineer.

## ENSURE LINTEL IS LEVEL ALONG ITS LENGTH

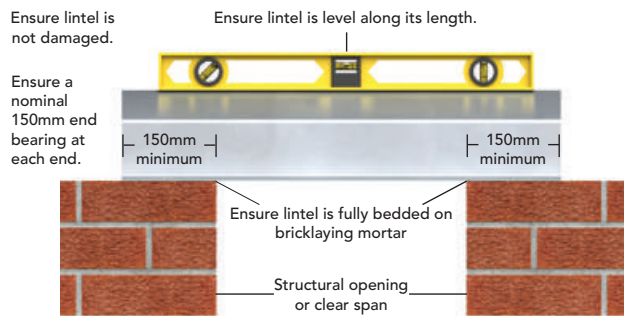

## LINTEL POSITION WITHIN A CAVITY WALL

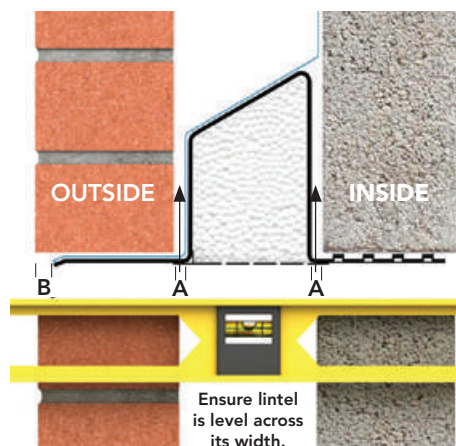

In accordance with BS EN 1996-2:2006 and NHBC requirements all external wall lintels **MUST** be installed with a flexible damp proof course with the exception of those adequately protected by an eaves overhang or similar form of protection.

**A** Lintel should be centred in the cavity and the distance between lintel up-stand and masonry must not exceed 10mm

**B** Masonry should not overhang any flange by more than 25mm.

## PROPPING

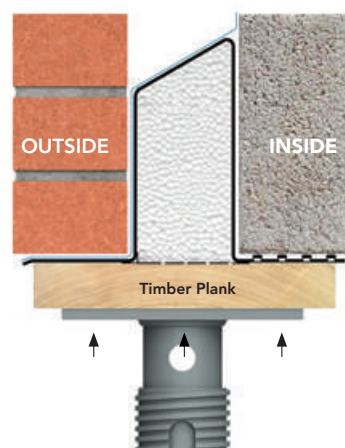

The practice of propping a lintel is sometimes used to facilitate speed of construction. It should only be introduced after initial masonry load has been applied to the lintel.

When propping a lintel, a horizontal timber plank should be placed along the underside of the lintel and suitable\* props secured into place at maximum 1200mm centres.

\* Suitability of props is the responsibility of site management.

# Selecting the correct lintel

## YOU WILL NEED TO KNOW 3 THINGS

- What is the wall construction?
- What is the length of the lintel?
- What is the load to be supported by the lintel?

### STAGE 1 - SELECT WALL TYPE

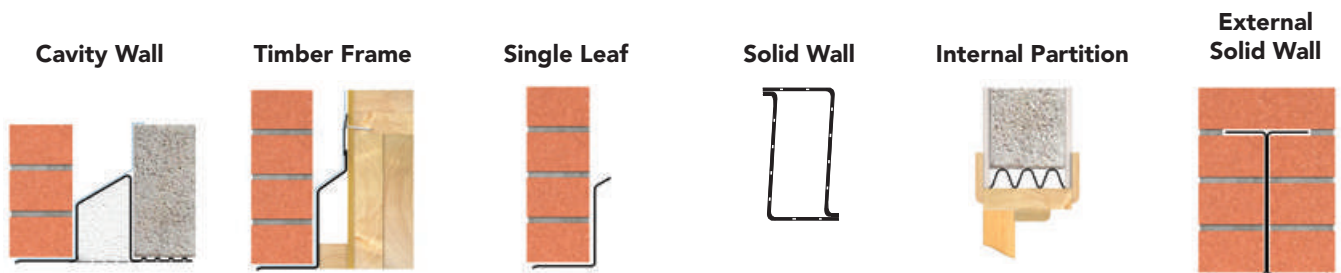

#### EXAMPLE 1. CAVITY WALL CONSTRUCTION

##### You will need to know:

- A** Outer Leaf = 102mm Brick
- B** Cavity = 100mm
- C** Inner Leaf = 100mm Block

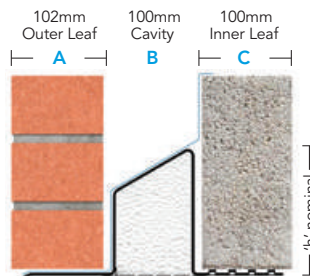

### STAGE 2 - WHAT IS THE LENGTH OF THE LINTEL?

#### EXAMPLE 2: LINTEL LENGTH

##### How wide is the structural opening?

- 1 Measure the size of the structural opening i.e. the clear span between the masonry supports.
- 2 Add 150mm minimum bearing to each end.

Example lintel length =  
150 + 1800 + 150 = 2100mm

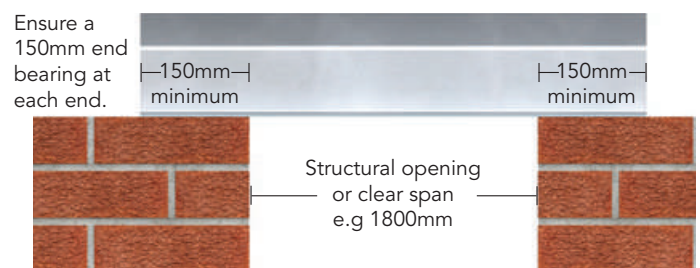

### STAGE 3 - WHAT IS THE LOAD TO BE SUPPORTED BY THE LINTEL?

#### EXAMPLE 3: LOAD ON LINTEL

##### The load on a lintel comes from...

- 1 Masonry
- 2 Roof Loads: Truss/Attic/Cut/...
- 3 Floor Loads: Joists/Slabs/...
- 4 Live Loads: Residential use  
Commercial use/Industrial use/...
- 5 Combination of above

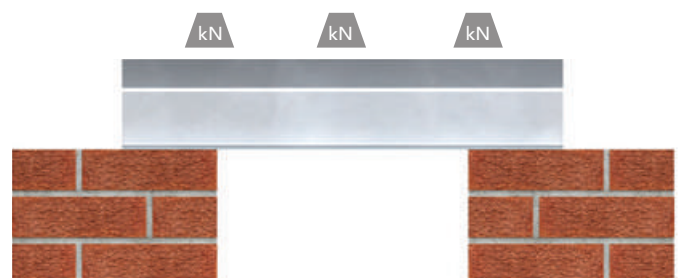





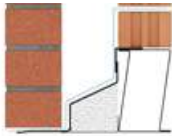
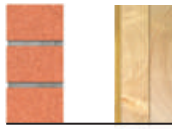

**NOTE** The load ratio between outer and inner leaves of the cavity wall will need to be determined. If you are not skilled in assessing loads please contact Keystone's Technical Team and avail of our free scheduling service.

# Lintel Range Index

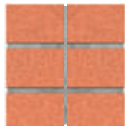
SECTION		HI-THERM+ GRP/STEEL LINTEL				
1	CAVITY WALL	<b>HI-THERM+ GRP/STEEL LINTEL</b> <b>Psi 0.05 W/m.K</b> Cavity Width 90-165mm	   102   Cavity   100	<b>LOADING TYPE</b> Standard Loading	<b>CODE</b> HT/S+	<b>PAGE</b> 11
				<b>GALVANISED STEEL LINTEL RANGE</b>		
2	CAVITY WALL	<b>100MM INNER LEAF</b> Cavity Width 50mm-165mm	   102   Cavity   100	<b>LOADING TYPE</b> Standard Loading	<b>CODE</b> S/K	<b>PAGE</b> 13
				Heavy Duty Loading	HD/K	14
					XHD/K	15
				Extra Heavy Duty Loading	CFS/K	16
					XCFS/K	17
		Extreme Loading	X/K	18		
3	CAVITY WALL	<b>125MM-150MM INNER LEAF</b> Cavity Width 50mm-165mm	   102   Cavity   150	<b>LOADING TYPE</b> Standard Loading	<b>CODE</b> S/K WIL	<b>PAGE</b> 20
				Heavy Duty Loading	HD/K WIL	21
					XHD/K WIL	22
				Extra Heavy Duty Loading	CFS/K WIL	23
					XCFS/K WIL	24
		Extreme Loading	X/K WIL	25		
		<b>215MM INNER LEAF</b> Cavity Width 50mm-165mm	   102   Cavity   215	Standard Loading	S/K 215 WIL	26
				Heavy Duty Loading	HD/K 215 WIL	27
				Extreme Loading	X/K 215 WIL	28
4	CAVITY WALL	<b>125MM-150MM OUTER LEAF</b> Cavity Width 50mm-165mm	   150   Cavity   100	<b>LOADING TYPE</b> Standard Loading	<b>CODE</b> S/K WOL	<b>PAGE</b> 30
				Heavy Duty Loading	HD/K WOL	31
					XHD/K WOL	32
				Extra Heavy Duty Loading	CFS/K WOL	33
					XCFS/K WOL	34
		Extreme Loading	X/K WOL	35		
		<b>215MM OUTER LEAF</b> Cavity Width 50mm-165mm	   215   Cavity   100	Standard Loading	S/K 215 WOL	36
5	CAVITY WALL	<b>EAVES LINTEL</b>		<b>LOADING TYPE</b> Standard Loading	<b>CODE</b> EL/K 90	<b>PAGE</b> 37



SECTION					
<b>6</b> PORO THERM	<b>PORO THERM</b>  Various Cavity Widths		<b>LOADING TYPE</b> Standard Loading	<b>CODE</b> See 2 part spec	<b>PAGE</b> 38
				See 2 part spec	39
				See 2 part spec	39
<b>7</b> TIMBER FRAME	<b>TIMBER FRAME</b>  Various Cavity Widths		<b>LOADING TYPE</b> Standard Loading	<b>CODE</b> T/K	<b>PAGE</b> 41
			Heavy Duty Loading	HDT/K	42
			Extra Heavy Duty Loading	XHDT/K	40
<b>SOLID WALL</b>					
<b>8</b> SOLID WALL	<b>SINGLE LEAF</b>		<b>LOADING TYPE</b> Standard Loading	<b>CODE</b> SB/K	<b>PAGE</b> 43
			Heavy Duty Loading	SL/K	43
<b>9</b> SOLID WALL	<b>BOX LINTEL</b>		<b>LOADING TYPE</b> Standard Loading	<b>CODE</b> BOX/K-75	<b>PAGE</b> 44
				BOX/K-100	45
				BOX/K-150	45
				BOX/K-200	45
			Heavy Duty Loading	HD BOX/K-100	46
				HD BOX/K-150	46
				HD BOX/K-200	47
<b>10</b> SOLID WALL	<b>100MM SOLID WALL</b>		<b>LOADING TYPE</b> Standard Loading	<b>CODE</b> INT/K-100	<b>PAGE</b> 48
				SW/K-100	48
	<b>215MM SOLID WALL</b>		<b>LOADING TYPE</b> Standard Loading	<b>CODE</b> SW/K	<b>PAGE</b> 48
			Heavy Loading	IB/K-2C	49
			Extra Heavy Loading	IB/K-3C	49
			Extreme Loading	IBX/K	49
<b>EXTENDED LINTEL RANGE</b>					
<b>11</b> EXTENDED LINTEL RANGE	<b>EXTENDED LINTEL RANGE</b>  Various Cavity Widths		<b>LOADING TYPE</b> Roller Shutter	<b>CODE</b> —	<b>PAGE</b> 50
			Cant Brick/Stepped Lintel	—	51
			Feature Plate	—	51
			Universal Arch Lintel	—	51
			Weep Vents & Stop Ends	—	52
				—	52
<b>STAINLESS STEEL LINTEL RANGE</b>					
<b>12</b> STAINLESS STEEL RANGE	<b>STAINLESS STEEL LINTEL RANGE</b>  Various Cavity Widths		Keystone Standard Lintels are also available in stainless steel. Outstanding durability through austenitic chromium nickel steel BS EN 10088-part 2 Astm 240 (European Grade 1.4307). Suitable for use in coastal and industrial environments. All Keystone galvanised steel loading tables apply.		
					<b>PAGE</b> 53

# 1

## CAVITY WALL HI-THERM+ LINTEL

Range  
Cavity Widths 90-165mm  
100mm Inner Leaf

The low cost solution to reduced carbon emissions and improved Fabric Energy Efficiency

Keystone leads the way with the development of a completely unique lintel range to address the thermal requirements of new building regulations which require that lintels should be assessed for their effect on the thermal performance of a building. The thermal performance of a lintel is expressed in terms of Psi Values ( $\Psi$ ) i.e. linear thermal transmittance.

10

Psi 0.03 - 0.06 W/m.k

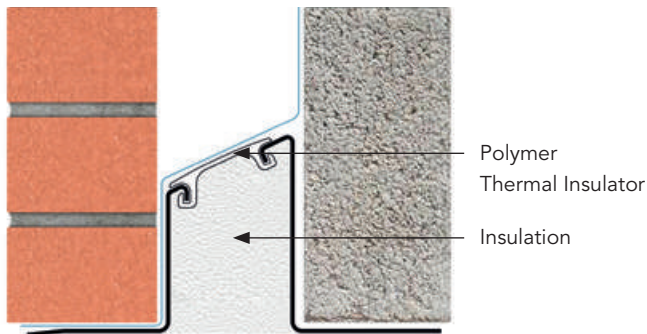

### Psi COMPARISON CHART

Hi-therm+ can achieve the Appendix R value for steel lintels in Part L 2013 depending on the wall construction. This table shows how Hi-therm+ outperforms all other lintel types.

LINTEL TYPE COMPARISON	VALUES
<b>Keystone Hi-therm+ Lintel</b>	<b>0.03-0.06 W/m.K</b>
Part L Appendix R value	0.5 W/m.K
Standard Lintel	0.22 W/m.K
Default Non Plated Steel Lintel	0.33 W/m. K
Plated Steel Lintel (Default) Table K1	0.5 W/m. K

\* Depending on wall construction

### KEY BENEFITS

- Up to 5 times more thermally efficient than a standard steel cavity wall lintel.
- Hi-therm+ is the only BBA approved thermally enhanced lintel on the market.
- Hi-therm+ achieves the Appendix R value for steel lintels in Part L.
- Hi-therm+ is a low cost solution to improving both the CO<sup>2</sup> & Fabric targets in line with Part L Building Regulations.
- Hi-therm+ will assist with achieving Part L with 100mm cavity therefore reducing the need for wider cavities.
- Hi-therm+ will assist with part L compliance without the need for renewable technologies.
- Better Buildability - offers the simplicity of a one piece, structurally superior top hat design creating stability during the building process, unlike a two part lintel solution.
- Maintenance free.

# HI-THERM+ LINTEL

Cavity widths from 90mm-165mm

**OUTER LEAF  
102mm**

**INNER LEAF  
100mm**

## HT/S+ STANDARD LOAD

Blockwork built tight against inner face of the lintel. Place mortar bed on top of blockwork before floor units are laid to provide even distribution of load. Lintels may be propped to facilitate speed of construction. See Lintel Installation on page 6.



### HT/S+ 100 (For cavity widths 90 -105)

Manufactured Length 150 increments	600- 1200	1350- 1500	1650- 1800	1950- 2100	2250- 2400	2550- 2700	2850- 3000	3150- 3600	3750- 4200
Height (h)	100	107	150	150	175	190	190	234	234
Thickness	1.6	2.0	2.0	2.0/2.5	2.0/2.5	2.5	2.5/2.9	2.9	3.2
Total UDL kN 3:1	12	16	19	21	23	27	27	27	27
Total UDL kN 19:1	10	13	16	17	18	22	20	20	22

### Standard Load

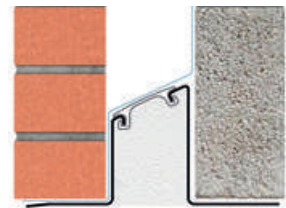

11

### HT/S+ 110 (For cavity widths 110 -125)

Manufactured Length 150 increments	600- 1500	1650- 1800	1950- 2100	2250- 3000	3150- 3600	3750- 4200
Height (h)	118	118	130	190	234	234
Thickness	2.0	2.0/2.5	2.5	2.5/2.9	2.9	3.2
Total UDL kN 3:1	16	22	21	27	27	27
Total UDL kN 19:1	13	18	17	22	20	22

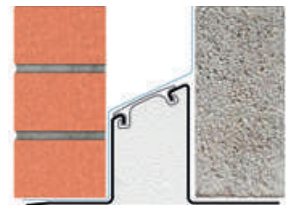

### HT/S+ 130 (For cavity widths 130 -145)

Manufactured Length 150 increments	600- 1500	1650- 1800	1950- 2100	2250- 3000	3150- 3600	3750- 4200
Height (h)	118	118	130	190	234	234
Thickness	2.0	2.0/2.5	2.5	2.5/2.9	2.9	3.2
Total UDL kN 3:1	16	22	21	27	27	27
Total UDL kN 19:1	13	18	17	22	20	22



### HT/S+ 150 (For cavity widths 150 -165)

Manufactured Length 150 increments	600- 1500	1650- 1800	1950- 2100	2250- 3000	3150- 3600	3750- 4200
Height (h)	118	118	130	190	234	234
Thickness	2.0	2.0/2.5	2.5	2.5/2.9	2.9	3.2
Total UDL kN 3:1	16	22	21	27	27	27
Total UDL kN 19:1	13	18	17	22	20	22



# 2

## CAVITY WALL 100mm INNER LEAF

Range  
Cavity Widths 50-165mm  
100mm Inner Leaf

Please use this table to identify the Lintel code required based on cavity width and loading. Contact our technical department for more details on these lintel options. Please note that only a selection of the range is illustrated in this manual.

12

### 100MM INNER LEAF

		LOADING					
CAVITY WIDTH	Cavity Width (mm)	Standard	Heavy Duty	Heavy Duty	Extra Heavy Duty	Extra Heavy Duty	Extreme
	* 50-65	S/K-50	HD/K-50	XHD/K-50	CFS/K-50	XCFS/K-50	X/K-50
	* 70-85	S/K-70	HD/K-70	XHD/K-70	CFS/K-70	XCFS/K-70	X/K-70
	90-105	S/K-90	HD/K-90	XHD/K-90	CFS/K-90	XCFS/K-90	X/K-90
	110-125	S/K-110	HD/K-110	XHD/K-110	CFS/K-110	XCFS/K-110	X/K-110
	* 130-145	S/K-130	HD/K-130	XHD/K-130	CFS/K-130	XCFS/K-130	X/K-130
	150-165	S/K-150	HD/K-150	XHD/K-150	CFS/K-150	XCFS/K-150	X/K-150

\*These cavity widths are not illustrated in this manual - please contact our technical department for details.

**Lintel Hotlines**

UK - 01283 200 150

N.I - 028 8676 2184

ROI - 048 8676 2184

Fax Back Enquiry Forms are available for download at [www.keystonelintels.com](http://www.keystonelintels.com)

# CAVITY WALL

Cavity widths from 50mm-165mm

<b>OUTER LEAF</b>	<b>INNER LEAF</b>
<b>102mm</b>	<b>100mm</b>

## S/K

Blockwork built tight against inner face of the lintel. Place mortar bed on top of blockwork before floor units are laid to provide even distribution of load. Lintels may be propped to facilitate speed of construction. See Lintel Installation on page 6.



## Standard Load

### S/K-90 (For cavity widths 90-105mm)

Manufactured length 150mm increments	600-1200	1350-1500	1650-1800	1950-2100	2250-2400	2550-2700	2850-3000	3150-3600	3750-4000	4200-4800
Height 'h'	88	85	107	125	150	162	171	200	200	200
Thickness	1.6	2.0	2.0	2.0	2.0	2.6	2.6	3.2	3.2	3.4
Total UDL kN 3:1	12	16	19	21	23	27	27	27	26	27
Total UDL kN 19:1	10	13	16	17	18	22	20	20	19	22

### 90-105mm Cavity

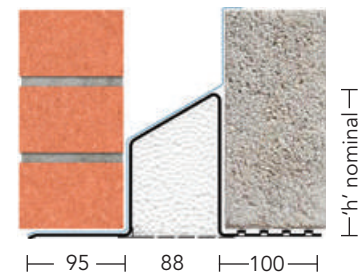

### S/K-110 (For cavity widths 110-125mm)

Manufactured length 150mm increments	600-1500	1650-1800	1950-2100	2250-2700	2850-3000	3150-4000	4200-4800
Height 'h'	97	113	125	163	193	193	218
Thickness	2.0	2.0	2.0	2.5	2.9	3.2	3.2
Total UDL kN 3:1	16	22	21	25	27	26	25
Total UDL kN 19:1	13	18	17	20	22	19	20

### 110-125mm Cavity

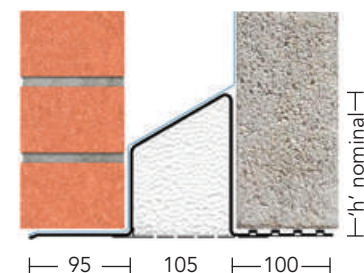

### S/K-150 (For cavity widths 150-165mm)

Manufactured length 150mm increments	600-1500	1650-1800	1950-2100	2250-2700	2850-3000	3150-4000	4200-4800
Height 'h'	100	118	130	148	173	173	199
Thickness	2.0	2.0	2.0	2.5	2.9	3.2	3.2
Total UDL kN 3:1	16	22	21	25	27	26	25
Total UDL kN 19:1	13	18	17	20	22	19	20

### 150-165mm Cavity

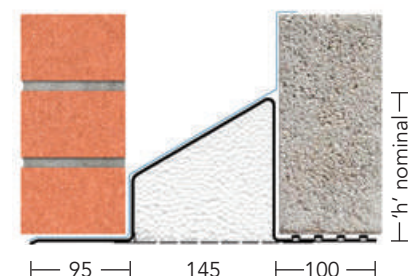

## CAVITY WALL

Cavity widths from 50mm-165mm

**OUTER LEAF**  
**102mm**

**INNER LEAF**  
**100mm**

### HD/K

Blockwork built tight against inner face of the lintel.  
Place mortar bed on top of blockwork before floor units are laid to provide even distribution of load. Lintels may be propped to facilitate speed of construction.  
See Lintel Installation on page 6.



## Heavy Duty Load

14

### HD/K-90 (For cavity widths 90-105mm)

Manufactured length 150mm increments	600- 1200	1350- 1500	1650- 2100	2250- 2550	2700- 3000	3150- 3600	3750- 4200
Height 'h'	110	135	163	203	203	203	203
Thickness	2.9	2.9	2.9	2.9	3.2	3.2	3.2
Total UDL kN 3:1	30	30	40	40	40	35	33
Total UDL kN 19:1	22	22	35	35	35	32	28

### 90-105mm Cavity

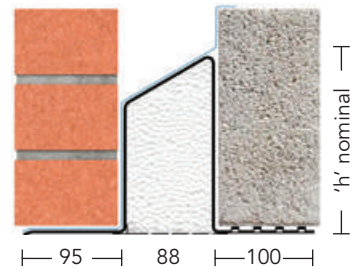

### HD/K-110 (For cavity widths 110-125mm)

Manufactured length 150mm increments	600- 1500	1650- 2100	2250- 3000	3150- 3600	3750- 4000
Height 'h'	125	145	195	195	195
Thickness	2.9	2.9	3.2	3.2	3.2
Total UDL kN 3:1	30	30	35	32	30
Total UDL kN 19:1	20	22	30	28	26

### 110-125mm Cavity

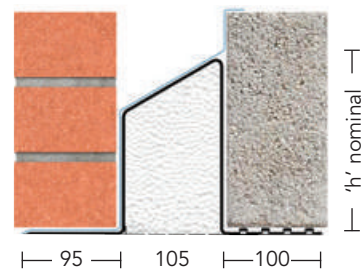

### HD/K-150 (For cavity widths 150-165mm)

Manufactured length 150mm increments	600- 1500	1650- 2100	2250- 3000	3150- 3600	3750- 4000
Height 'h'	125	160	180	180	200
Thickness	2.9	2.9	3.2	3.2	3.2
Total UDL kN 3:1	30	30	35	30	30
Total UDL kN 19:1	20	22	30	25	26

### 150-165mm Cavity

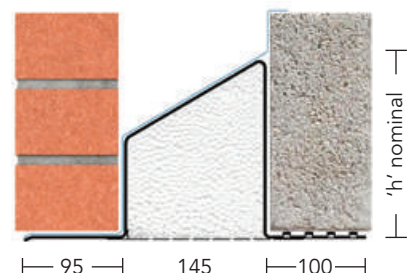

## Cavity widths from 50mm-165mm

**OUTER LEAF**  
**102mm**

**INNER LEAF**  
**100mm**

### XHD/K

Blockwork built tight against inner face of the lintel.  
Place mortar bed on top of blockwork before floor units are laid to provide even distribution of load. Lintels may be propped to facilitate speed of construction.  
See Lintel Installation on page 6.



## Heavy Duty Load

### XHD/K-90 (For cavity widths 90-105mm)

Manufactured length 150mm increments	600- 1500	1650- 1800	1950- 2100	2250- 2700
Height 'h'	163	163	203	203
Thickness	3.2	3.2	3.2	3.2
Total UDL kN 3:1	50	50	55	50
Total UDL kN 19:1	45	45	45	40

### 90-105mm Cavity

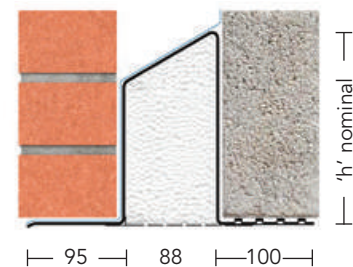

15

### XHD/K-110 (For cavity widths 110-125mm)

Manufactured length 150mm increments	600- 1500	1650- 1800	1950- 2100
Height 'h'	145	145	195
Thickness	3.2	3.2	3.2
Total UDL kN 3:1	45	45	50
Total UDL kN 19:1	40	40	40

### 110-125mm Cavity

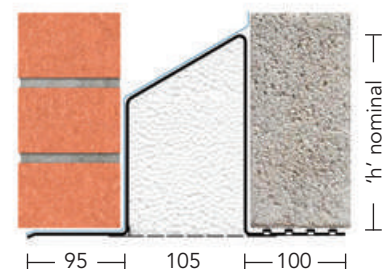

### XHD/K-150 (For cavity widths 150-165mm)

Manufactured length 150mm increments	600- 1500	1650- 1800	1950- 2100
Height 'h'	160	160	200
Thickness	3.2	3.2	3.2
Total UDL kN 3:1	45	45	50
Total UDL kN 19:1	40	40	40

### 150-165mm Cavity

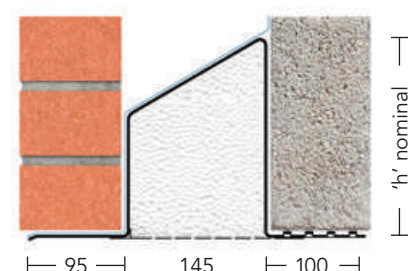

## CAVITY WALL

Cavity widths from 50mm-165mm

**OUTER LEAF**  
**102mm**

**INNER LEAF**  
**100mm**

### CFS/K

To achieve loading figures lintel must be built in with blockwork as shown. Ensure all perpendicular and horizontal joints are filled with mortar. Place mortar bed on top of blockwork before floor units are laid to provide even distribution of load. Lintels may be propped to facilitate speed of construction. See Lintel Installation on page 6.



## Extra Heavy Duty Load

16

### CFS/K-90 (For cavity widths 90-105mm)

Manufactured length 150mm increments	600- 2400	2550- 3600	3750- 4800
Height 'h'	229	229	229
Thickness	2.5	3.0	3.0
Total UDL kN 19:1	48	50	38

### 90-105mm Cavity

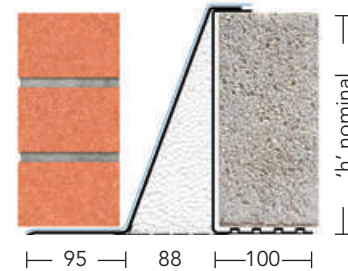

### CFS/K-110 (For cavity widths 110-125mm)

Manufactured length 150mm increments	600- 2400	2550- 3600	3750- 4800
Height 'h'	229	229	229
Thickness	2.5	3.0	3.0
Total UDL kN 19:1	48	50	38

### 110-125mm Cavity

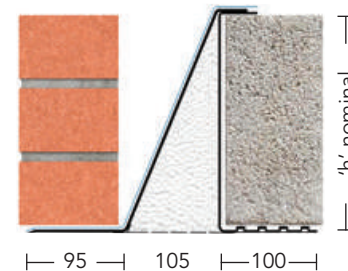

### CFS/K-150 (For cavity widths 150-165mm)

Manufactured length 150mm increments	600- 2400	2550- 3600	3750- 4800
Height 'h'	229	229	229
Thickness	2.5	3.0	3.0
Total UDL kN 19:1	48	50	38

### 150-165mm Cavity

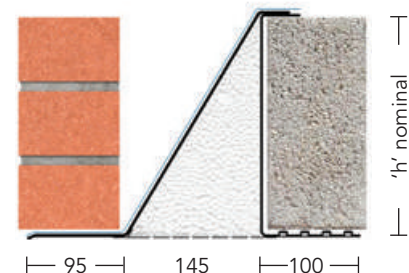



## Cavity widths from 50mm-165mm

**OUTER LEAF**  
**102mm**

**INNER LEAF**  
**100mm**

### XCFS/K

To achieve loading figures lintel must be built in with blockwork as shown. Ensure all perpendicular and horizontal joints are filled with mortar. Place mortar bed on top of blockwork before floor units are laid to provide even distribution of load. Lintels may be propped to facilitate speed of construction. See Lintel Installation on page 6.



## Extra Heavy Duty Load

### XCFS/K-90 (For cavity widths 90-105mm)

Manufactured length 150mm increments	600- 1800	1950- 2400	2550- 3000	3150- 3600	3750- 4800
Height 'h'	235	235	235	235	235
Thickness Inner	5.0	5.0	5.0	5.0	5.0
Thickness Outer	2.9	2.9	2.9	3.2	3.2
Total UDL kN 19:1	100	90	80	65	50

### 90-105mm Cavity

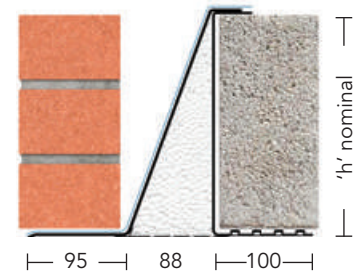

17

### XCFS/K-110 (For cavity widths 110-125mm)

Manufactured length 150mm increments	600- 1800	1950- 2400	2550- 3000	3150- 3600	3750- 4800
Height 'h'	235	235	235	235	235
Thickness Inner	5.0	5.0	5.0	5.0	5.0
Thickness Outer	2.9	2.9	2.9	3.2	3.2
Total UDL kN 19:1	100	90	80	65	50

### 110-125mm Cavity

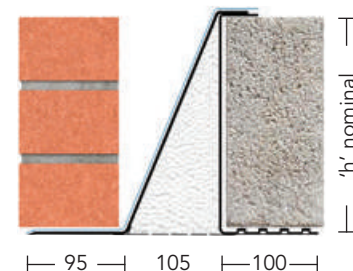

### XCFS/K-150 (For cavity widths 150-165mm)

Manufactured length 150mm increments	600- 1800	1950- 2400	2550- 3000	3150- 3600	3750- 4800
Height 'h'	235	235	235	235	235
Thickness Inner	5.0	5.0	5.0	5.0	5.0
Thickness Outer	2.9	2.9	2.9	3.2	3.2
Total UDL kN 19:1	100	90	80	65	50

### 150-165mm Cavity

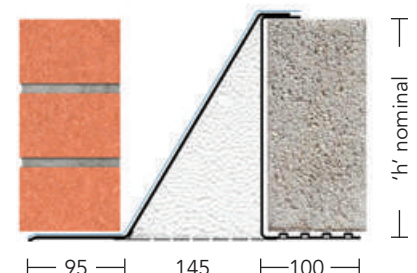

## CAVITY WALL

Cavity widths from 50mm-165mm

**OUTER LEAF**  
**102mm**

**INNER LEAF**  
**100mm**

### X/K

To achieve loading figures lintel must be laterally restrained. Lintels may be propped to facilitate speed of construction. See Lintel Installation on page 6. Galvanised steel flange to outer leaf.



## Extreme Load

18

### X/K-90 (For cavity widths 90-105mm)

Manufactured length (mm) to customer requirements	600-4800	5200	5400	5800	6200	6600
End Bearing	200	200	200	200	200	200
Total UDL kN 19.1	80	70	62	55	45	40

### 90-105mm Cavity

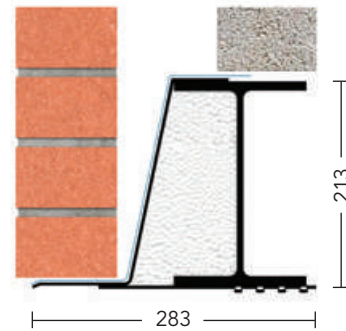

### X/K-110 (For cavity widths 110-125mm)

Manufactured length (mm) to customer requirements	600-4800	5200	5400	5800	6200	6600
End Bearing	200	200	200	200	200	200
Total UDL kN 19.1	80	70	62	55	45	40

### 110-125mm Cavity

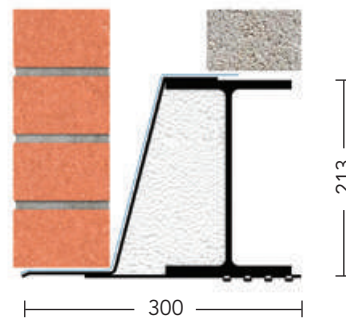

### X/K-150 (For cavity widths 150-165mm)

Manufactured length (mm) to customer requirements	600-4800	5200	5400	5800	6200	6600
End Bearing	200	200	200	200	200	200
Total UDL kN 19.1	80	70	62	55	45	40

### 150-165mm Cavity

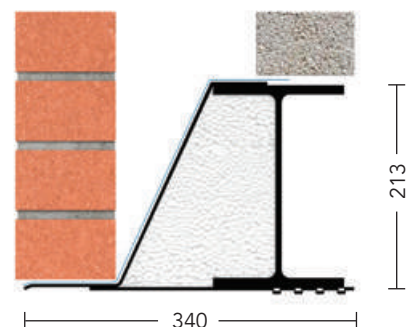

# 3

## CAVITY WALL WIDE INNER LEAF

Range  
Cavity Widths 50-165mm  
125-150mm Inner Leaf  
215mm Inner Leaf

Please use this table to identify the lintel code required based on cavity width and loading.  
Contact our technical department for more details on these lintel options.  
Please note that only a selection of the range is illustrated in this manual.

### 125MM - 150MM INNER LEAF

		LOADING					
CAVITY WIDTH	Cavity Widths (mm)	Standard	Heavy Duty	Heavy Duty	Extra Heavy Duty	Extra Heavy Duty	Extreme
	* 50-65	S/K-50 WIL	HD/K-50 WIL	XHD/K-50 WIL	CFS/K-50 WIL	XCFS/K-50 WIL	X/K-50 WIL
	* 70-85	S/K-70 WIL	HD/K-70 WIL	XHD/K-70 WIL	CFS/K-70 WIL	XCFS/K-70 WIL	X/K-70 WIL
	90-105	S/K-90 WIL	HD/K-90 WIL	XHD/K-90 WIL	CFS/K-90 WIL	XCFS/K-90 WIL	X/K-90 WIL
	110-125	S/K-110 WIL	HD/K-110 WIL	XHD/K-110 WIL	CFS/K-110 WIL	XCFS/K-110 WIL	X/K-110 WIL
	* 130-145	S/K-130 WIL	HD/K-130 WIL	XHD/K-130 WIL	CFS/K-130 WIL	XCFS/K-130 WIL	X/K-130 WIL
	150-165	S/K-150 WIL	HD/K-150 WIL	XHD/K-150 WIL	CFS/K-150 WIL	XCFS/K-150 WIL	X/K-150 WIL

\*These cavity widths are not illustrated in this manual - please contact our technical department for details.

### 215MM INNER LEAF

		LOADING		
CAVITY WIDTH	Cavity Widths (mm)	Standard	Heavy Duty	Extreme
	* 50-65	S/K-50 WIL 215	HD/K-50 WIL 215	X/K-50 WIL 215
	* 70-85	S/K-70 WIL 215	HD/K-70 WIL 215	X/K-70 WIL 215
	90-105	S/K-90 WIL 215	HD/K-90 WIL 215	X/K-90 WIL 215
	110-125	S/K-110 WIL 215	HD/K-110 WIL 215	X/K-110 WIL 215
	* 130-145	S/K-130 WIL 215	HD/K-130 WIL 215	X/K-130 WIL 215
	150-165	S/K-150 WIL 215	HD/K-150 WIL 215	X/K-150 WIL 215

\*These cavity widths are not illustrated in this manual - please contact our technical department for details.

**Lintel Hotlines**  
UK - 01283 200 150  
N.I - 028 8676 2184  
ROI - 048 8676 2184

Fax Back Enquiry Forms are available for download at [www.keystonelintels.com](http://www.keystonelintels.com)

## CAVITY WALL - WIDE INNER LEAF

Cavity widths from 50mm-165mm

**OUTER LEAF**  
**102mm**

**INNER LEAF**  
**125mm-150mm**

### S/K WIL

Lintels may be propped to facilitate speed of construction. See Lintel Installation on page 6. Inner leaf block should not overhang the lintel flange by more than 25mm.



## Standard Load

For 150mm wide inner leaf blockwork.

20

### S/K-90 WIL (For cavity widths 90-105mm)

Manufactured length 150mm increments	600-1200	1350-1800	1950-2400	2550-3000	3150-3600	3750-4000	4200
Height 'h'	82	107	142	177	191	187	187
Thickness	1.6	2.0	2.0	2.6	3.2	3.2	3.4
Total UDL kN 3:1	13	17	23	24	30	27	26
Total UDL kN 19:1	11	14	18	18	26	25	21

### 90-105mm Cavity

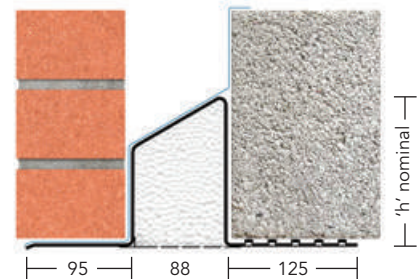

### S/K-110 WIL (For cavity widths 110-125mm)

Manufactured length 150mm increments	600-1200	1350-1800	1950-2100	2250-3000	3150-4000
Height 'h'	95	107	142	185	185
Thickness	2.0	2.0	2.5	2.9	3.2
Total UDL kN 3:1	13	17	23	24	24
Total UDL kN 19:1	11	14	18	18	17

### 110-125mm Cavity

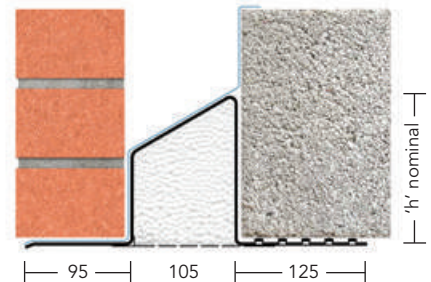

### S/K-150 WIL (For cavity widths 150-165mm)

Manufactured length 150mm increments	600-1200	1350-1800	1950-2100	2250-3000	3150-4000
Height 'h'	88	115	168	168	168
Thickness	2.0	2.0	2.5	2.9	3.2
Total UDL kN 3:1	13	17	23	24	24
Total UDL kN 19:1	11	14	18	18	17

### 150-165mm Cavity

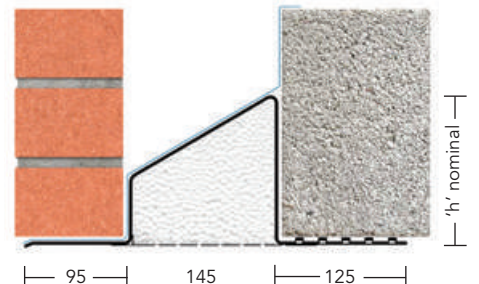

## Cavity widths from 50mm-165mm

**OUTER LEAF  
102mm**

**INNER LEAF  
125mm-150mm**

### HD/K WIL

Lintels may be propped to facilitate speed of construction. See Lintel Installation on page 6. Inner leaf block should not overhang the lintel flange by more than 25mm. Blockwork built tight against inner face of the lintel. Place mortar bed on top of blockwork before floor units are laid to provide even distribution of load.



## Heavy Duty Load

For 150mm wide inner leaf blockwork.

### HD/K-90 WIL (For cavity widths 90-105mm)

Manufactured length 150mm increments	600- 1350	1500- 1800	1950- 2100	2250- 2700
Height 'h'	113	144	188	188
Thickness	2.9	2.9	2.9	3.2
Total UDL kN 3:1	20	35	30	36
Total UDL kN 19:1	17	27	25	32

### 90-105mm Cavity

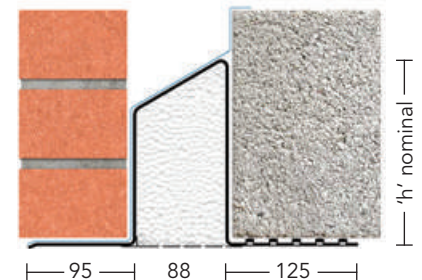

### HD/K-110 WIL (For cavity widths 110-125mm)

Manufactured length 150mm increments	600- 1350	1500- 1800	1950- 2100	2250- 2700
Height 'h'	131	148	195	195
Thickness	2.9	2.9	2.9	3.2
Total UDL kN 3:1	20	30	30	36
Total UDL kN 19:1	17	25	25	32

### 110-125mm Cavity

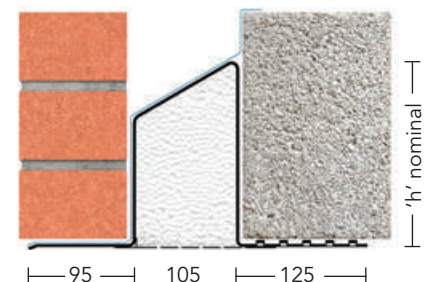

For 150mm wide inner leaf blockwork.

### HD/K-150 WIL (For cavity widths 150-165mm)

Manufactured length 150mm increments	600- 1350	1500- 1800	1950- 2100	2250- 2700
Height 'h'	115	168	180	200
Thickness	2.9	2.9	2.9	3.2
Total UDL kN 3:1	20	30	30	36
Total UDL kN 19:1	17	25	25	32

### 150-165mm Cavity

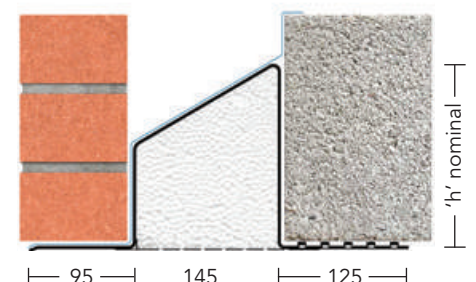

## CAVITY WALL - WIDE INNER LEAF

Cavity widths from 50mm-165mm

**OUTER LEAF**  
**102mm**

**INNER LEAF**  
**125mm-150mm**

### XHD/K WIL

Lintels may be propped to facilitate speed of construction. See Lintel Installation on page 6. Inner leaf block should not overhang the lintel flange by more than 25mm. Blockwork built tight against inner face of the lintel. Place mortar bed on top of blockwork before floor units are laid to provide even distribution of load.



## Heavy Duty Load For 150mm wide inner leaf blockwork.

22

### XHD/K-90 WIL (For cavity widths 90-105mm)

Manufactured length 150mm increments	600- 1500	1650- 1800	1950- 2100
Height 'h'	165	188	188
Thickness	3.2	3.2	3.2
Total UDL kN 3:1	45	50	45
Total UDL kN 19:1	40	40	40

### 90-105mm Cavity

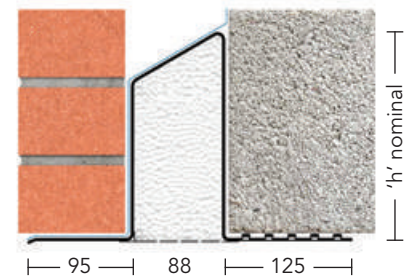

### XHD/K-110 WIL (For cavity widths 110-125mm)

Manufactured length 150mm increments	600- 1500	1650- 1800	1950- 2100
Height 'h'	185	195	195
Thickness	3.2	3.2	3.2
Total UDL kN 3:1	45	50	45
Total UDL kN 19:1	40	40	40

### 110-125mm Cavity

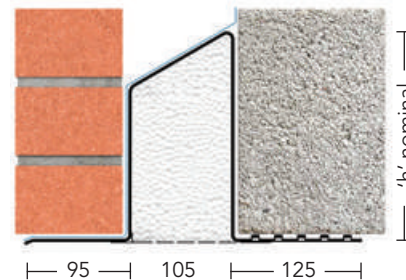

### XHD/K-150 WIL (For cavity widths 150-165mm)

Manufactured length 150mm increments	600- 1500	1650- 1800	1950- 2100
Height 'h'	180	200	200
Thickness	3.2	3.2	3.2
Total UDL kN 3:1	45	50	45
Total UDL kN 19:1	40	40	40

### 150-165mm Cavity

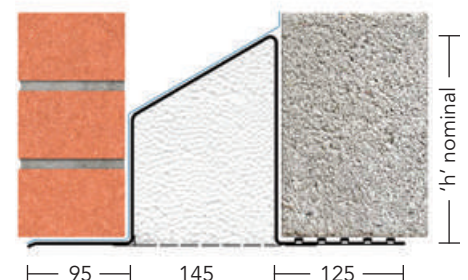

## Cavity widths from 50mm-165mm

**OUTER LEAF  
102mm**

**INNER LEAF  
125mm-150mm**

### CFS/K WIL

Lintels may be propped to facilitate speed of construction. See Lintel Installation on page 6. Inner leaf block should not overhang the lintel flange by more than 25mm. Blockwork built tight against inner face of the lintel. Place mortar bed on top of blockwork before floor units are laid to provide even distribution of load.



## Extra Heavy Duty Load

For 150mm wide inner leaf blockwork.

### CFS/K-90 WIL (For cavity widths 90-105mm)

Manufactured length 150mm increments	600- 1500	1650- 2100	2250- 3000	3150- 4000	4200- 4800
Height 'h'	229	229	229	229	229
Thickness	2.9	2.9	2.9	3.2	3.2
Total UDL kN 19:1	70	60	50	45	40

### 90-105mm Cavity

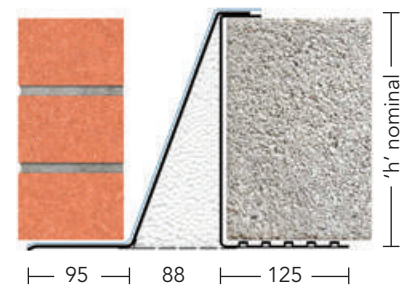

### CFS/K-110 WIL (For cavity widths 110-125mm)

Manufactured length 150mm increments	600- 1500	1650- 2100	2250- 3000	3150- 4000	4200- 4800
Height 'h'	229	229	229	229	229
Thickness	2.9	2.9	2.9	3.2	3.2
Total UDL kN 19:1	70	60	50	45	40

### 110-125mm Cavity

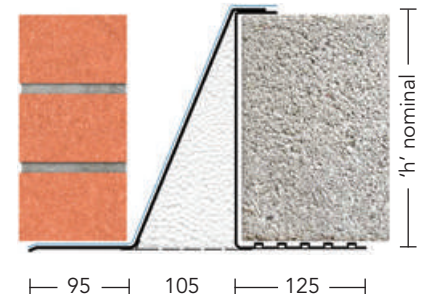

### CFS/K-150 WIL (For cavity widths 150-165mm)

Manufactured length 150mm increments	600- 1500	1650- 2100	2250- 3000	3150- 4000	4200- 4800
Height 'h'	229	229	229	229	229
Thickness	2.9	2.9	2.9	3.2	3.2
Total UDL kN 19:1	70	60	50	45	40

### 150-165mm Cavity

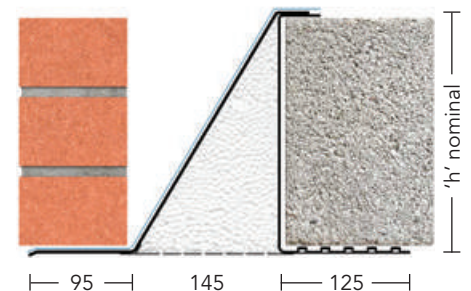

## CAVITY WALL - WIDE INNER LEAF

Cavity widths from 50mm-165mm

**OUTER LEAF**  
**102mm**

**INNER LEAF**  
**125mm-150mm**

### XCFS/K WIL

Lintels may be propped to facilitate speed of construction. See Lintel Installation on page 6. Inner leaf block should not overhang the lintel flange by more than 25mm. Blockwork built tight against inner face of the lintel. Place mortar bed on top of blockwork before floor units are laid to provide even distribution of load.



## Extra Heavy Duty Load

For 150mm wide inner leaf blockwork.

24

### XCFS/K-90 WIL (For cavity widths 90-105mm)

Manufactured length 150mm increments	600- 1800	1950- 2400	2550- 3000	3150- 3600
Height 'h'	235	235	235	235
Thickness Inner	5.0	5.0	5.0	5.0
Thickness Outer	2.9	2.9	2.9	3.2
Total UDL kN 19:1	100	90	80	65

### 90-105mm Cavity

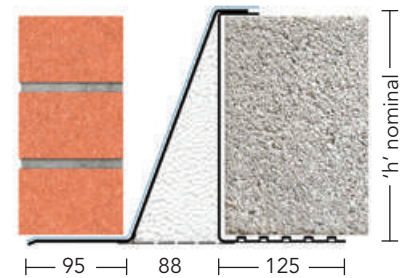

### XCFS/K-110 WIL (For cavity widths 110-125mm)

Manufactured length 150mm increments	600- 1800	1950- 2400	2550- 3000	3150- 3600
Height 'h'	235	235	235	235
Thickness Inner	5.0	5.0	5.0	5.0
Thickness Outer	2.9	2.9	2.9	3.2
Total UDL kN 19:1	100	90	80	65

### 110-125mm Cavity

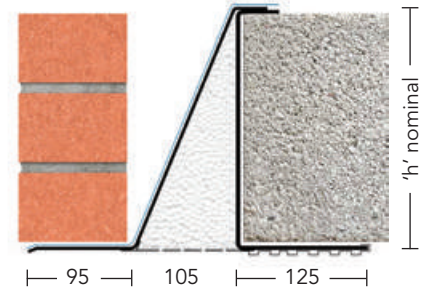

### XCFS/K-150 WIL (For cavity widths 150-165mm)

Manufactured length 150mm increments	600- 1800	1950- 2400	2550- 3000	3150- 3600
Height 'h'	235	235	235	235
Thickness Inner	5.0	5.0	5.0	5.0
Thickness Outer	2.9	2.9	2.9	3.2
Total UDL kN 19:1	100	90	80	65

### 150-165mm Cavity

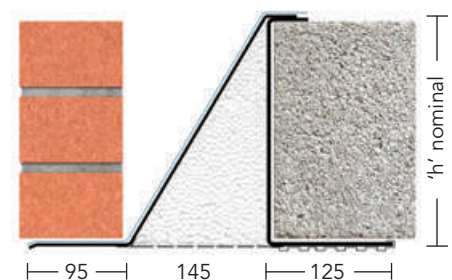



Cavity widths from 50mm-165mm

**OUTER LEAF  
102mm**

**INNER LEAF  
140mm - 150mm**

## X/K WIL

To achieve loading figures lintel must be laterally restrained. Lintels may be propped to facilitate speed of construction. See Lintel Installation on page 6.

For 125mm wide inner leaf cross section may vary.



## Extreme Load For 150mm wide inner leaf blockwork.

### X/K-90 WIL (For cavity widths 90-105mm)

Manufactured length (mm) to customer requirements	600-4800	5200	5400	5800	6200	6600
End Bearing	200	200	200	200	200	200
Total UDL kN 19:1	80	70	62	55	45	40

### X/K-110 WIL (For cavity widths 110-125mm)

Manufactured length (mm) to customer requirements	600-4800	5200	5400	5800	6200	6600
End Bearing	200	200	200	200	200	200
Total UDL kN 19:1	80	70	62	55	45	40

### X/K-150 WIL (For cavity widths 150-165mm)

Manufactured length (mm) to customer requirements	600-4800	5200	5400	5800	6200	6600
End Bearing	200	200	200	200	200	200
Total UDL kN 19:1	80	70	62	55	45	40

### 90-105mm Cavity

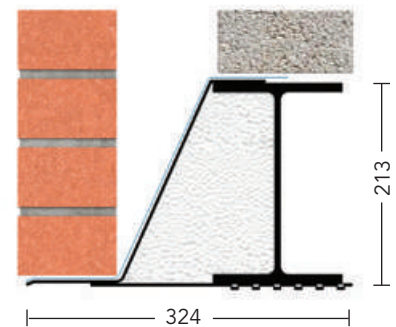

### 110-125mm Cavity

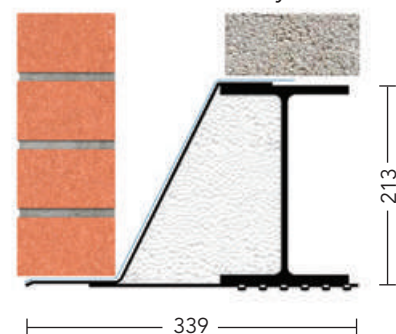

### 150-165mm Cavity

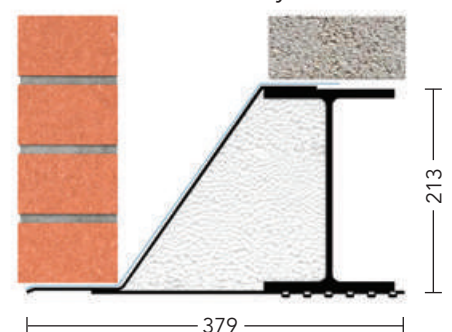

# CAVITY WALL - WIDE INNER LEAF 215

Cavity widths from 50mm-165mm

<b>OUTER LEAF</b>	<b>INNER LEAF</b>
<b>102mm</b>	<b>215mm</b>

## S/K 215 WIL

Lintels may be propped to facilitate speed of construction. See Lintel Installation on page 6. Inner leaf block should not overhang the lintel flange by more than 25mm.

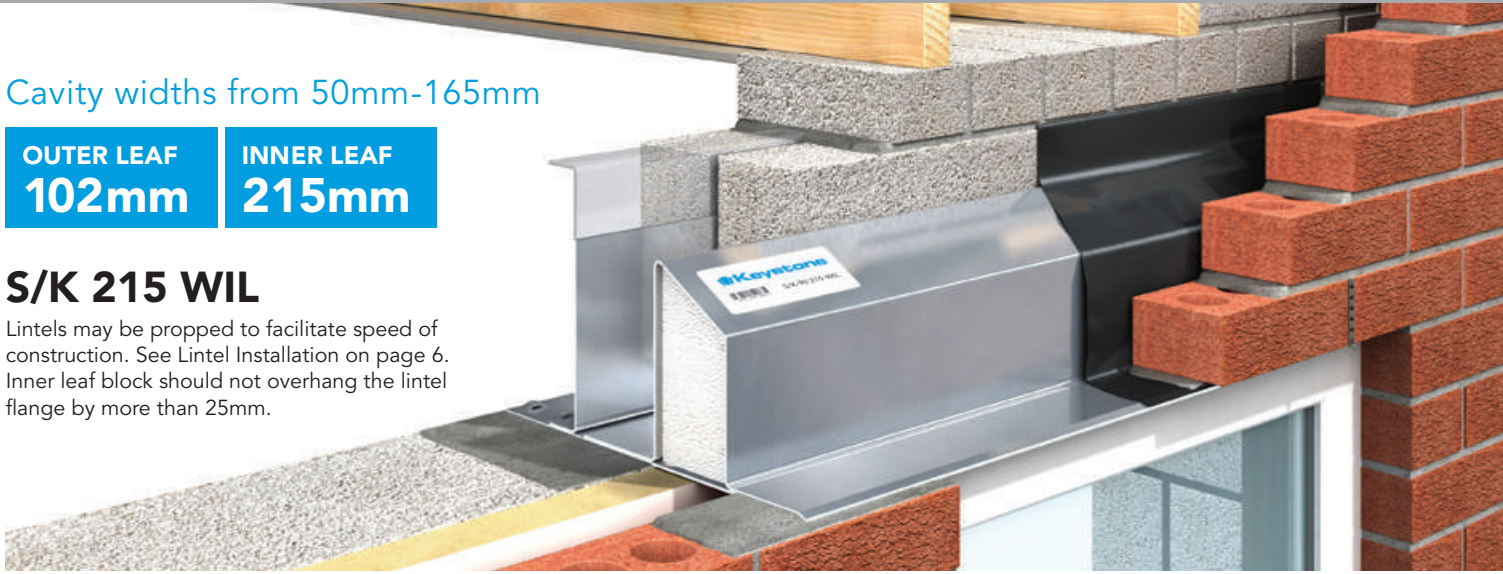

## Standard Load

For 215mm wide inner leaf blockwork.

### S/K-90 215 WIL (For cavity widths 90-105mm)

Manufactured length 150mm increments	600-1350	1500-1650	1800-2100	2250-2400	2550-2700	2850-3000	3150-4000
Height 'h'	105	105	138	163	163	200	200
Thickness	2.5	2.5	2.5	2.5	2.9	2.9	2.9
Total UDL kN 3:1	25	25	30	35	40	40	40
Total UDL kN 19:1	20	20	25	30	35	35	35
Fin Height	100	120	175	225	225	225	225

### 90-105mm Cavity

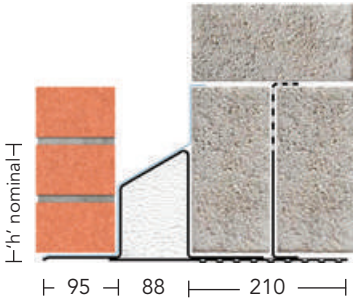

### S/K-110 215 WIL (For cavity widths 110-125mm)

Manufactured length 150mm increments	600-1500	1650-1800	1950-2100	2250-3000	3150-4000
Height 'h'	97	125	145	193	193
Thickness	2.5	2.5	2.5	2.9	3.2
Total UDL kN 3:1	25	25	30	35	40
Total UDL kN 19:1	20	20	25	30	35
Fin Height	120	140	175	225	225

### 110-125mm Cavity

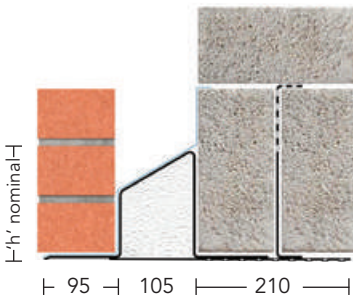

### S/K-150 215 WIL (For cavity widths 150-165mm)

Manufactured length 150mm increments	600-1500	1650-1800	1950-2100	2250-3000	3150-4000
Height 'h'	100	130	173	199	199
Thickness	2.5	2.5	2.5	2.9	3.2
Total UDL kN 3:1	25	25	30	35	40
Total UDL kN 19:1	20	20	25	30	35
Fin Height	120	140	175	225	225

### 150-165mm Cavity

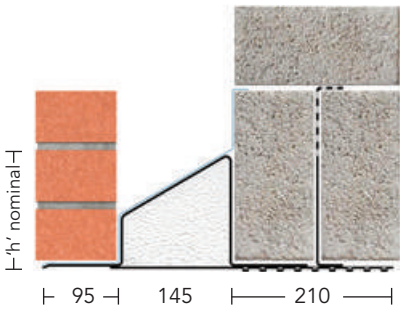

Cavity widths from 50mm-165mm

**OUTER LEAF**  
**102mm**

**INNER LEAF**  
**215mm**

## HD/K 215 WIL

Lintels may be propped to facilitate speed of construction. See Lintel Installation on page 6. Inner leaf block should not overhang the lintel flange by more than 25mm.

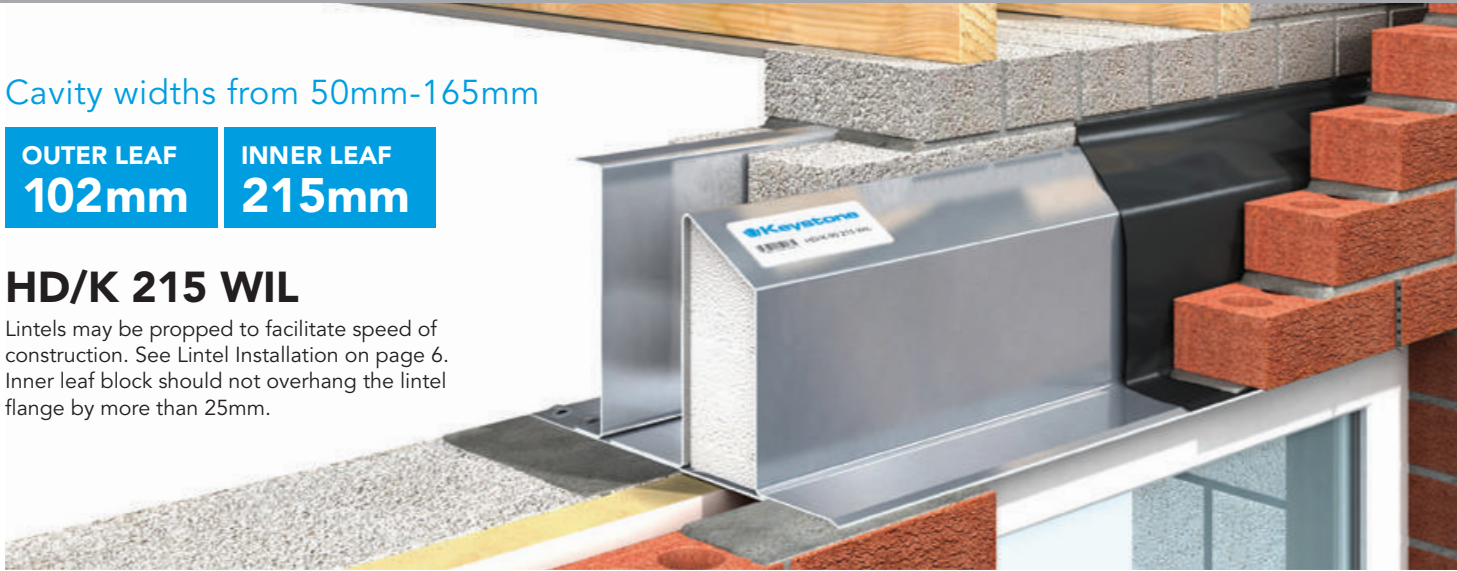

## Heavy Duty Load

For 215mm wide inner leaf blockwork.

### HD/K-90 215 WIL (For cavity widths 90-105mm)

Manufactured length 150mm increments	600- 1500	1650- 1800	1950- 2100
Height 'h'	145	200	200
Thickness	2.5	2.5	2.9
Total UDL kN 3:1	40	45	50
Total UDL kN 19:1	35	40	45
Fin Height	175	225	225

### 90-105mm Cavity

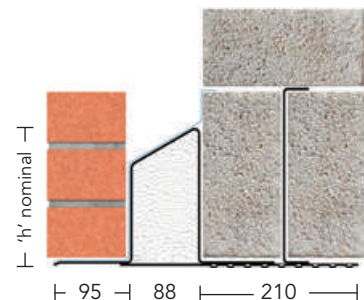

### HD/K-110 215 WIL (For cavity widths 110-125mm)

Manufactured length 150mm increments	600- 1500	1650- 1800	1950- 2100
Height 'h'	145	195	195
Thickness	2.5	2.9	3.2
Total UDL kN 3:1	40	45	50
Total UDL kN 19:1	35	40	45
Fin Height	175	225	225

### 110-125mm Cavity

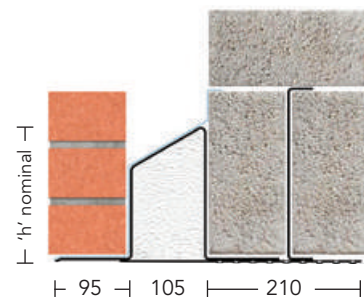

### HD/K-150 215 WIL (For cavity widths 150-165mm)

Manufactured length 150mm increments	600- 1500	1650- 1800	1950- 2100
Height 'h'	173	199	199
Thickness	2.5	2.9	3.2
Total UDL kN 3:1	40	45	50
Total UDL kN 19:1	35	40	45
Fin Height	175	225	225

### 150-165mm Cavity

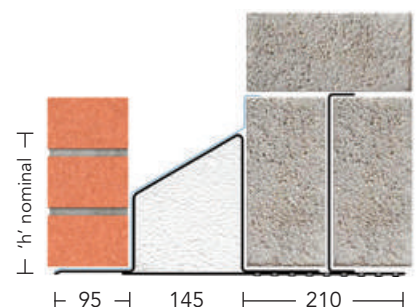

## CAVITY WALL - WIDE INNER LEAF 215

Cavity widths from 50mm-165mm

**OUTER LEAF**  
**102mm**

**INNER LEAF**  
**215mm**

### X/K 215 WIL

To achieve loading figures lintel must be laterally restrained. Lintels may be propped to facilitate speed of construction. See Lintel Installation on page 6.



## Extreme Load For 215mm wide inner leaf blockwork.

28

### X/K-90 215 WIL (For cavity widths 90-105mm)

Manufactured length (mm) to customer requirements	600-4800	5200	5400	5800	6200	6600
End Bearing	200	200	200	200	200	200
Total UDL kN 19:1	80	70	62	55	45	40

### 90-105mm Cavity

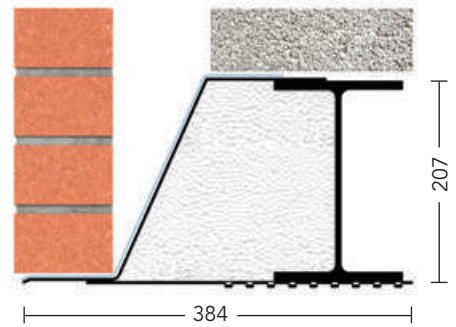

### 110-125mm Cavity

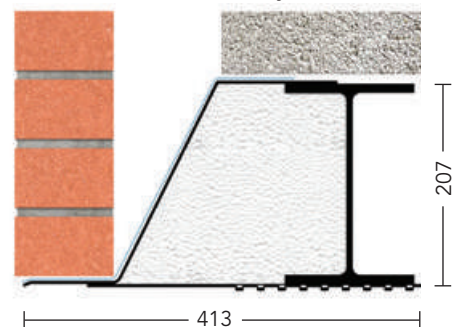

### 150-165mm Cavity

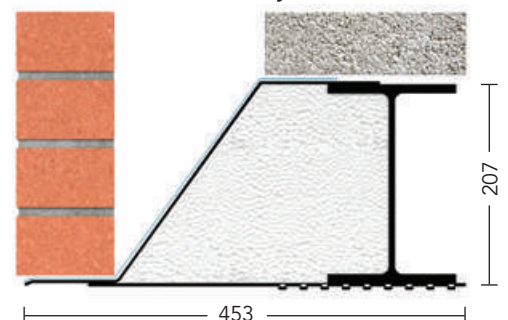

### X/K-110 215 WIL (For cavity widths 110-125mm)

Manufactured length (mm) to customer requirements	600-4800	5200	5400	5800	6200	6600
End Bearing	200	200	200	200	200	200
Total UDL kN 19:1	80	70	62	55	45	40

### X/K-150 215 WIL (For cavity widths 150-165mm)

Manufactured length (mm) to customer requirements	600-4800	5200	5400	5800	6200	6600
End Bearing	200	200	200	200	200	200
Total UDL kN 19:1	80	70	62	55	45	40

# 4

## CAVITY WALL WIDE OUTER LEAF

Range





Cavity Widths 50-165mm

125-150mm Outer Leaf

215mm Outer Leaf

Please use this table to identify the Lintel code required based on cavity width and loading.  
Contact our technical department for more details on these lintel options.  
Please note that only a selection of the range is illustrated in this manual.

### 125-150MM OUTER LEAF

		LOADING					
CAVITY WIDTH	Cavity Widths (mm)	Standard	Heavy Duty	Heavy Duty	Extra Heavy Duty	Extra Heavy Duty	Extreme
	* 50-65	S/K-50 WOL	HD/K-50 WOL	XHD/K-50 WOL	CFS/K-50 WOL	XCFS/K-50 WOL	X/K-50 WOL
	* 70-85	S/K-70 WOL	HD/K-70 WOL	XHD/K-70 WOL	CFS/K-70 WOL	XCFS/K-70 WOL	X/K-70 WOL
	90-105	S/K-90 WOL	HD/K-90 WOL	XHD/K-90 WOL	CFS/K-90 WOL	XCFS/K-90 WOL	X/K-90 WOL
	110-125	S/K-110 WOL	HD/K-110 WOL	XHD/K-110 WOL	CFS/K-110 WOL	XCFS/K-110 WOL	X/K-110 WOL
	* 130-145	S/K-130 WOL	HD/K-130 WOL	XHD/K-130 WOL	CFS/K-130 WOL	XCFS/K-130 WOL	X/K-130 WOL
	150-165	S/K-150 WOL	HD/K-150 WOL	XHD/K-150 WOL	CFS/K-150 WOL	XCFS/K-150 WOL	X/K-150 WOL
							

\*These cavity widths are not illustrated in this manual - please contact our technical department for details.

### 215MM OUTER LEAF

		LOADING
CAVITY WIDTH	Cavity Widths (mm)	Standard
	* 50-65	S/K-50 215 WOL
	* 70-85	S/K-70 215 WOL
	90-105	S/K-90 215 WOL
	110-125	S/K-110 215 WOL
	* 130-145	S/K-130 215 WOL
	150-165	S/K-150 215 WOL
		

\*These cavity widths are not illustrated in this manual - please contact our technical department for details.

**Lintel Hotlines**  
 UK - 01283 200 150  
 N.I - 028 8676 2184  
 ROI - 048 8676 2184

Fax Back Enquiry Forms are available for  
 download at [www.keystonelintels.com](http://www.keystonelintels.com)

## CAVITY WALL - WIDE OUTER LEAF

Cavity widths from 50mm-165mm

**OUTER LEAF**

**125mm-150mm**

**INNER LEAF**

**100mm**

### S/K WOL

To achieve loading figures lintel must be built in with blockwork as shown. Maximum overhang of 30mm on outer leaf. Lintels may be propped to facilitate speed of construction. See Lintel Installation on page 6.



## Standard Load

For 150mm wide outer leaf blockwork/stonework.

30

### S/K-90 WOL (For cavity widths 90-105mm)

Manufactured length 150mm increments	600- 1350	1500- 1650	1800- 2100	2250- 2700	2850- 3000	3150- 3600
Height 'h'	93	110	162	188	188	188
Thickness	2.5	2.5	2.5	2.9	2.9	3.2
Total UDL kN 3:1	14	15	23	30	32	30
Total UDL kN 19:1	11	13	18	22	30	26

### 90-105mm Cavity

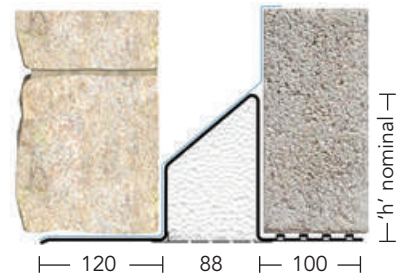

### S/K-110 WOL (For cavity widths 110-125mm)

Manufactured length 150mm increments	600- 1350	1500- 1650	1800- 2100	2250- 2700	2850- 3000	3150- 3600
Height 'h'	95	107	142	185	185	185
Thickness	2.5	2.5	2.5	2.9	3.2	3.2
Total UDL kN 3:1	14	15	23	30	32	30
Total UDL kN 19:1	11	13	18	22	30	26

### 110-125mm

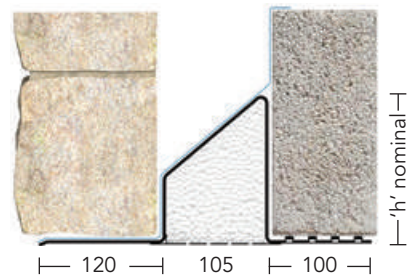

### S/K-150 WOL (For cavity widths 150-165mm)

Manufactured length 150mm increments	600- 1350	1500- 1650	1800- 2100	2250- 2700	2850- 3000	3150- 3600
Height 'h'	88	115	168	168	168	168
Thickness	2.5	2.5	2.5	2.9	3.2	3.2
Total UDL kN 3:1	14	15	23	30	32	30
Total UDL kN 19:1	11	13	18	22	30	26

### 150-165mm Cavity

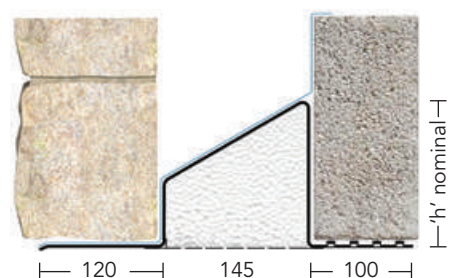

Cavity widths from 50mm-165mm

**OUTER LEAF  
125mm-150mm**

**INNER LEAF  
100mm**

## HD/K WOL

To achieve loading figures lintel must be built in with blockwork as shown. Maximum overhang of 30mm on outer leaf. Lintels may be propped to facilitate speed of construction. See Lintel Installation on page 6.



## Heavy Duty Load

For 150mm wide outer leaf blockwork/stonework.

### HD/K-90 WOL (For cavity widths 90-105mm)

Manufactured length 150mm increments	600- 1350	1500- 1800	1950- 2100	2250- 2700
Height 'h'	123	148	188	188
Thickness	2.9	2.9	2.9	3.2
Total UDL kN 3:1	20	30	30	36
Total UDL kN 19:1	17	25	25	32

### 90-105mm Cavity

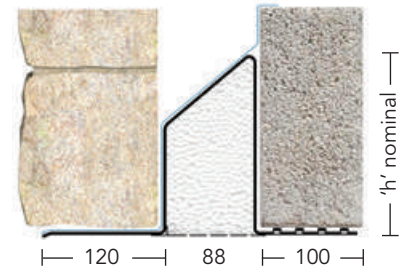

### HD/K-110 WOL (For cavity widths 110-125mm)

Manufactured length 150mm increments	600- 1350	1500- 1800	1950- 2100	2250- 2700
Height 'h'	131	148	195	195
Thickness	2.9	2.9	2.9	3.2
Total UDL kN 3:1	20	30	30	36
Total UDL kN 19:1	17	25	25	32

### 110-125mm Cavity

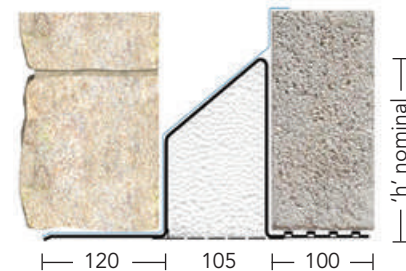

### HD/K-150 WOL (For cavity widths 150-165mm)

Manufactured length 150mm increments	600- 1350	1500- 1800	1950- 2100	2250- 2700
Height 'h'	113	168	180	200
Thickness	2.9	2.9	2.9	3.2
Total UDL kN 3:1	20	30	30	36
Total UDL kN 19:1	17	25	25	32

### 150-165mm Cavity

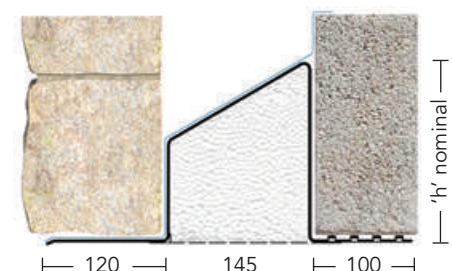

## CAVITY WALL - WIDE OUTER LEAF

Cavity widths from 50mm-165mm

**OUTER LEAF**  
**125mm-150mm**

**INNER LEAF**  
**100mm**

### XHD/K WOL

Lintels may be propped to facilitate speed of construction. See Lintel Installation on page 6. Blockwork built tight against inner face of the lintel. Maximum overhang of 30mm on outer leaf. Place mortar bed on top of blockwork before floor units are laid to provide even distribution of load.



## Heavy Duty Load For 150mm wide outer leaf blockwork/stonework.

32

### XHD/K-90 WOL (For cavity widths 90-105mm)

Manufactured length 150mm increments	600- 1500	1650- 1800	1950- 2100
Height 'h'	165	188	188
Thickness	3.2	3.2	3.2
Total UDL kN 3:1	45	45	50
Total UDL kN 19:1	40	40	40

### 90-105mm Cavity

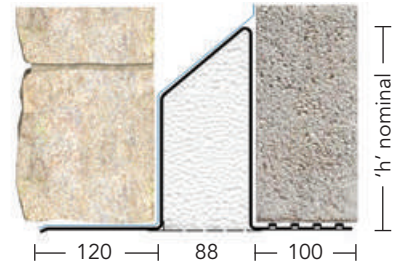

### XHD/K-110 WOL (For cavity widths 110-125mm)

Manufactured length 150mm increments	600- 1500	1650- 1800	1950- 2100
Height 'h'	195	195	195
Thickness	3.2	3.2	3.2
Total UDL kN 3:1	45	45	50
Total UDL kN 19:1	40	40	40

### 110-125mm Cavity

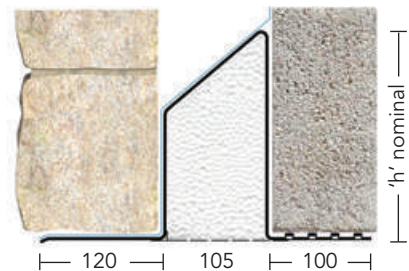

### XHD/K-150 WOL (For cavity widths 150-165mm)

Manufactured length 150mm increments	600- 1500	1650- 1800	1950- 2100
Height 'h'	180	200	200
Thickness	3.2	3.2	3.2
Total UDL kN 3:1	45	45	50
Total UDL kN 19:1	40	40	40

### 150-165mm Cavity

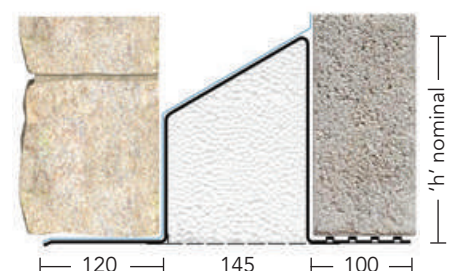



Cavity widths from 50mm-165mm

**OUTER LEAF  
125mm-150mm**

**INNER LEAF  
100mm**

## CFS/K WOL

To achieve loading figures lintel must be built in with blockwork as shown. Maximum overhang of 30mm on outer leaf. Ensure all perpendicular and horizontal joints are filled with mortar. Place mortar bed on top of blockwork before floor units are laid to provide even distribution of load. Lintels may be propped to facilitate speed of construction. See Lintel Installation on page 6.



## Extra Heavy Duty Load

For 150mm wide outer leaf blockwork/stonework.

### CFS/K-90 WOL (For cavity widths 90-105mm)

Manufactured length 150mm increments	600- 1500	1650- 2100	2250- 3000	3150- 4000	4200- 4800
Height 'h'	229	229	229	229	229
Thickness	2.9	2.9	2.9	3.2	3.2
Total UDL kN 19:1	70	60	50	45	40

### 90-105mm Cavity

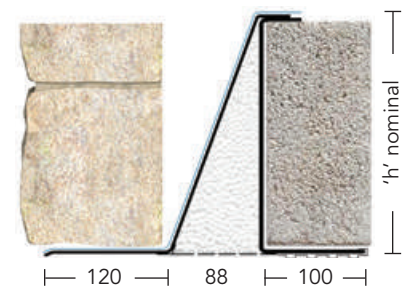

### CFS/K-110 WOL (For cavity widths 110-125mm)

Manufactured length 150mm increments	600- 1500	1650- 2100	2250- 3000	3150- 4000	4200- 4800
Height 'h'	229	229	229	229	229
Thickness	2.9	2.9	2.9	3.2	3.2
Total UDL kN 19:1	70	60	50	45	40

### 110-125mm Cavity

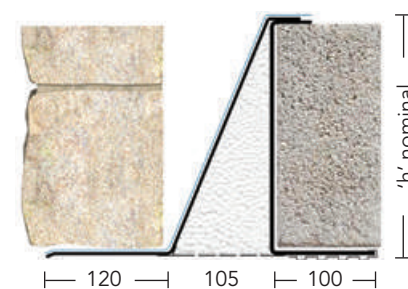

### CFS/K-150 WOL (For cavity widths 150-165mm)

Manufactured length 150mm increments	600- 1500	1650- 2100	2250- 3000	3150- 4000	4200- 4800
Height 'h'	229	229	229	229	229
Thickness	2.9	2.9	2.9	3.2	3.2
Total UDL kN 19:1	70	60	50	45	40

### 150-165mm Cavity

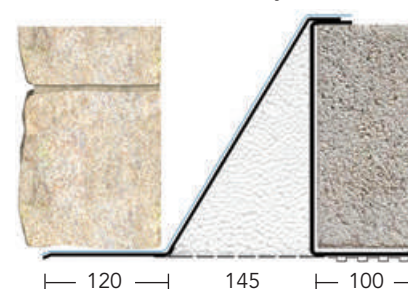

## CAVITY WALL - WIDE OUTER LEAF

Cavity widths from 50mm-165mm

OUTER LEAF

**125mm-150mm**

INNER LEAF

**100mm**

### XCFS/K WOL

To achieve loading figures lintel must be built in with blockwork as shown. Maximum overhang of 30mm on outer leaf. Ensure all perpendicular and horizontal joints are filled with mortar. Place mortar bed on top of blockwork before floor units are laid to provide even distribution of load. Lintels may be propped to facilitate speed of construction. See Lintel Installation on page 6.



## Extra Heavy Duty Load

For 150mm wide outer leaf blockwork/stonework.

34

### XCFS/K-90 WOL (For cavity widths 90-105mm)

Manufactured length 150mm increments	600- 1800	1950- 2400	2550- 3000	3150- 3600
Height 'h'	235	235	235	235
Thickness Inner	5.0	5.0	5.0	5.0
Thickness Outer	2.9	2.9	2.9	3.2
Total UDL kN 19:1	100	90	80	65

### 90-105mm Cavity

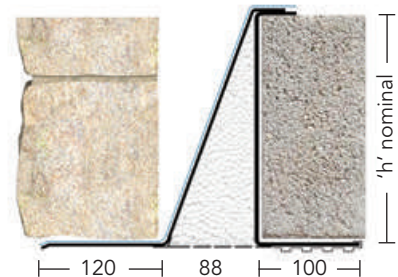

### XCFS/K-110 WOL (For cavity widths 110-125mm)

Manufactured length 150mm increments	600- 1800	1950- 2400	2550- 3000	3150- 3600
Height 'h'	235	235	235	235
Thickness Inner	5.0	5.0	5.0	5.0
Thickness Outer	2.9	2.9	2.9	3.2
Total UDL kN 19:1	100	90	80	65

### 110-125mm Cavity

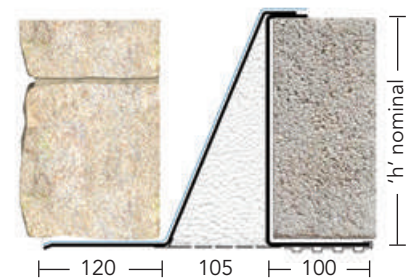

### XCFS/K-150 WOL (For cavity widths 150-165mm)

Manufactured length 150mm increments	600- 1800	1950- 2400	2550- 3000	3150- 3600
Height 'h'	235	235	235	235
Thickness Inner	5.0	5.0	5.0	5.0
Thickness Outer	2.9	2.9	2.9	3.2
Total UDL kN 19:1	100	90	80	65

### 150-165mm Cavity

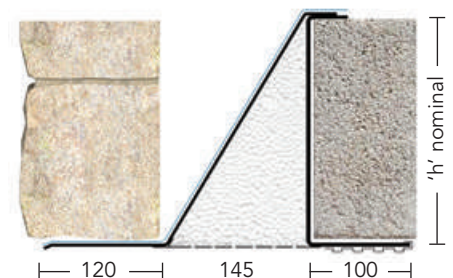

## Cavity widths from 50mm-165mm

**OUTER LEAF**  
**125mm-150mm**

**INNER LEAF**  
**100mm**

### X/K WOL

To achieve loading figures lintel must be built in with blockwork as shown. Maximum overhang of 30mm on outer leaf. Ensure all perpendicular and horizontal joints are filled with mortar. Place mortar bed on top of blockwork before floor units are laid to provide even distribution of load. Lintels may be propped to facilitate speed of construction. See Lintel Installation on page 6.



## Extreme Load

For 150mm wide outer leaf blockwork/stonework.

### X/K-90 WOL (For cavity widths 90-105mm)

Manufactured length (mm) to customers requirements	600-4800	5200	5400	5800	6200	6600
End Bearing	200	200	200	200	200	200
Total UDL kN 19:1	80	70	62	55	45	40

### 90-105mm Cavity

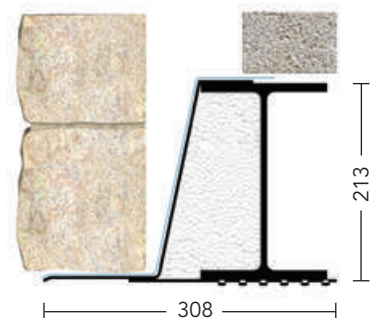

35

### X/K-110 WOL (For cavity widths 110-125mm)

Manufactured length (mm) to customers requirements	600-4800	5200	5400	5800	6200	6600
End Bearing	200	200	200	200	200	200
Total UDL kN 19:1	80	70	62	55	45	40

### 110-125mm Cavity

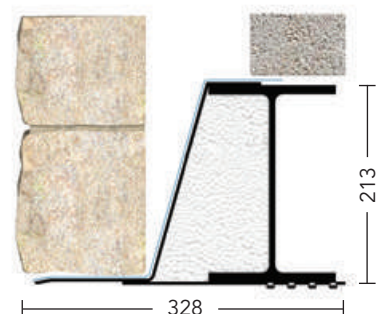

### X/K-150 WOL (For cavity widths 150-165mm)

Manufactured length (mm) to customers requirements	600-4800	5200	5400	5800	6200	6600
End Bearing	200	200	200	200	200	200
Total UDL kN 19:1	80	70	62	55	45	40

### 150-165mm Cavity



## CAVITY WALL - 215 WIDE OUTER LEAF

Cavity widths from 50mm-165mm

**OUTER LEAF**  
**215mm**

**INNER LEAF**  
**100mm**

### S/K 215 WOL

To achieve loading figures lintel must be built in with blockwork as shown. Maximum overhang of 30mm on outer leaf. Extended fin 225mm high for lintels greater than 2100mm in length. Lintels may be propped to facilitate speed of construction. See Lintel Installation on page 6.



## Standard Load

For 215mm wide outer leaf blockwork/stonework.

36

### S/K-90 215 WOL (For cavity widths 90-105mm)

Manufactured length 150mm increments	600-1200	1350-1500	1650-2100	2250-2550	2700-3000	3150-3600
Height 'h'	103	140	163	203	203	203
Thickness	2.9	2.9	2.9	2.9	3.2	3.2
Total UDL kN 3:1	30	30	30	40	40	35
Total UDL kN 19:1	22	22	22	35	35	32
Fin Height	100	120	175	225	225	225

### 90-105mm Cavity

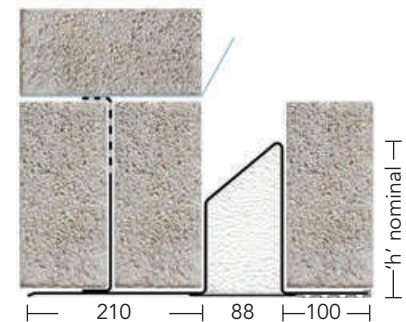

### S/K-110 215 WOL (For cavity widths 110-125mm)

Manufactured length 150mm increments	600-1500	1650-2100	2250-2550	2700-3000	3150-3600
Height 'h'	130	145	195	195	195
Thickness	2.9	2.9	2.9	3.2	3.2
Total UDL kN 3:1	30	30	35	35	32
Total UDL kN 19:1	20	22	30	30	28
Fin Height	120	175	225	225	225

### 110-125mm Cavity

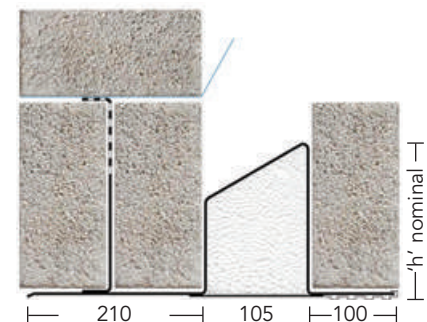

### S/K-150 215 WOL (For cavity widths 150-165mm)

Manufactured length 150mm increments	600-1500	1650-2100	2250-2550	2700-3000	3150-3600
Height 'h'	118	160	180	180	180
Thickness	2.9	2.9	2.9	3.2	3.2
Total UDL kN 3:1	30	30	35	35	30
Total UDL kN 19:1	20	22	30	30	25
Fin Height	120	175	225	225	225

### 150-165mm Cavity

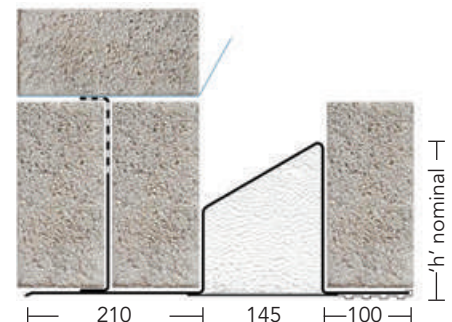

# 5

## CAVITY WALL EAVES LINTELS

Range  
Cavity Widths 50-125mm  
100mm Inner Leaf



EL/K lintels are designed to provide support over openings at eaves level. The eaves lintel has a shortened outer flange to allow the underside of the soffit board to be positioned tight against the window frame. It must be noted that brickwork cannot be built onto the outer flange of an eaves lintel. Masonry is built on the inner leaf only.

37

### EL/K-90 (For cavity widths 90 -125mm)

Manufactured length 150mm increments	600- 1500	1650- 2100	2250- 2400	2550- 2700
Height 'h'	106	144	163	164
Thickness	1.8	2.0	2.0	2.5
Total UDL kN 19:1	18	20	22	25

Please note Eaves Lintel is also available for cavity widths 50-85mm. Contact our technical team for more information.

The loading figures are achieved by considering the lintel and masonry as a composite unit.

The lintel must have a minimum end bearing of 150mm on each side of the opening bedded on mortar. Level the lintel along its length and across its width. The lintel must be positioned to ensure that the masonry is built against the vertical upstand of the lintel. Masonry should be bedded on mortar and all perpendicular joints filled with mortar.

A continuous timber wall plate must extend along the masonry immediately above the lintel. Lintel may be propped to facilitate speed of construction. A plaster key is incorporated into the inner leaf of the lintel.

The Keystone Eaves lintel also incorporates a thermal break plate on the underside of the lintel for superior structural performance.

### 90-125mm Cavity

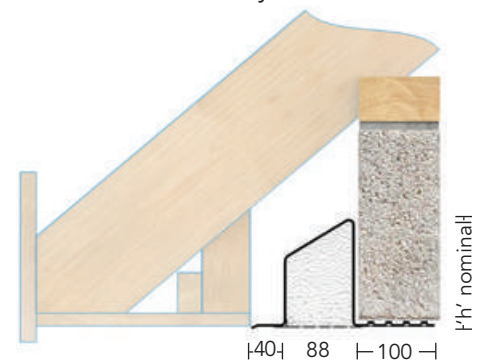

**Lintel Hotlines**  
UK - 01283 200 150  
N.I - 028 8676 2184  
ROI - 048 8676 2184

Fax Back Enquiry Forms are available for download at [www.keystonelintels.com](http://www.keystonelintels.com)

# 6

## Poro-Cav Lintel Range

Unique to the Porotherm Masonry System

### Poro Lintel System

38

#### PORO-CAV LINTEL RANGE

The Poro-Cav Lintel features a unique, patented 'thermal break plate' that enhances thermal performance.

The inner leaf is supported through a standard Keystone Box lintel with factory fitted lateral restraint clips. The outer leaf support comes from the uniquely designed outer lintel, which is easily clipped into position using the lateral restraint clip prefixed to the inner box lintel.

This system provides resistance to rotation during loading on site.

#### To suit cavity wall construction with 100mm Wide Inner Leaf

Manufactured length	600-1800	1950-2400	2550-2700	2850-3000
Height 'h'	150	150	150	215

#### Internal leaf specify PCI/K-100 (to suit 100mm Inner Leaf)

Total UDL kN	30	25	20	30
--------------	----	----	----	----

#### External leaf specify PCO/K-90 (to suit 90-105mm cavity)

Total UDL kN	5	8	9	12
--------------	---	---	---	----

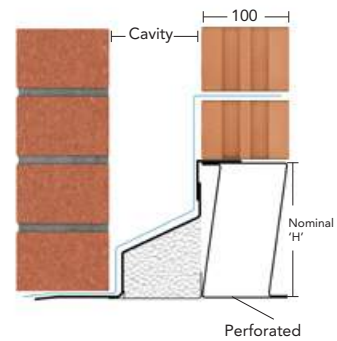

For wider cavities and heavy loadings contact our technical department

# PORO-CAV LINTEL

## WHAT IS POROTHERM?

Porotherm is a precision engineered modern clay block walling system. The system has revolutionised the construction industry through fast and dry construction with the benefits of high strength and thermal performance. Through the use of 1mm mortar beds using the special adhesive in comparison to the conventional 10mm joints, the Porotherm System brings many benefits associated with efficiency, quality and value retention.



### To suit cavity wall construction with 140mm Wide Inner Leaf

Manufactured length	<b>600-1800</b>	<b>1950-2400</b>	<b>2550-2700</b>	<b>2850-3000</b>
Height 'h'	150	150	150	215
<b>Internal leaf specify PCI/K-140 (to suit 140mm Inner Leaf)</b>				
Total UDL kN	30	25	20	35
<b>External leaf specify PCO/K-90 (to suit 90-105mm cavity)</b>				
Total UDL kN	5	8	9	12

For wider cavities and heavy loadings contact our technical department

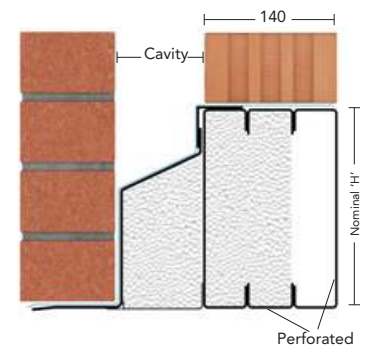

### To suit cavity wall construction with 190mm Wide Inner Leaf

Manufactured length	<b>600-1800</b>	<b>1950-2400</b>	<b>2550-2700</b>	<b>2850-3000</b>
Height 'h'	150	150	150	215
<b>Internal leaf specify PCI/K-190 (to suit 190mm Inner Leaf)</b>				
Total UDL kN	30	25	20	35
<b>External leaf specify PCO/K-90 (to suit 90-105mm cavity)</b>				
Total UDL kN	5	8	9	12

For wider cavities and heavy loadings contact our technical department

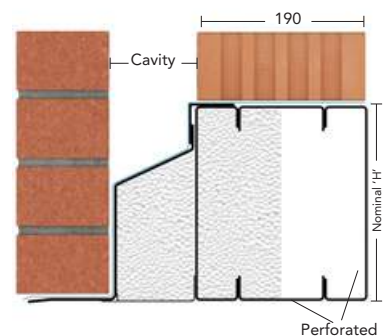

#### Lintel Hotlines

UK - 01283 200 150  
N.I - 028 8676 2184  
ROI - 048 8676 2184

Fax Back Enquiry Forms are available for download at [www.keystonelintels.com](http://www.keystonelintels.com)

# 7

## CAVITY WALL TIMBER FRAME LINTELS

Range  
Cavity Widths 50-100mm

Designed for use in timber frame construction the T/K lintels provide support to the outer leaf to brickwork over openings.

40

### POSITION OF LINTEL RESTRAINT CLIPS

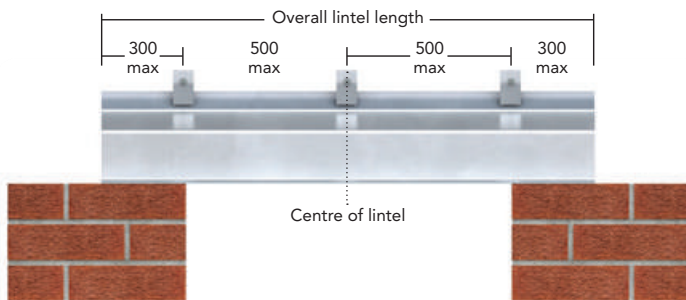

### INSTALLATION

Installation of Keystone's T/K, HDT/K and XHDT/K are all similar.

All Timber frame lintels must be installed with restraining clips and a timber pinch batten to prevent rotation of the lintel during the building stage. Propping may be used to facilitate speed of construction.

To achieve the loading figures shown, the T/K lintel must be secured with restraining clips and a timber pinch batten (not supplied must be used to prevent lateral deflection (rotation)

during the building stage. A single timber pinch batten 300mm long at mid span will be sufficient.

Keystone timber frame restraint clips are supplied free of charge and must be fixed to the timber frame structure by 3.3mm x 50mm galvanised nails. Allowance should be made for the movement of the timber frame structure due to settlement and shrinkage. Lateral restraint clip should be placed at 500mm centres each side of mid span.

### CLEARANCE



### SPECIFICATION

For material specifications, please see page 5. Architectural specification clauses and full NBS plus specifications are available at [www.keystonelintels.com](http://www.keystonelintels.com)

### XHDT/K EXTREME LOADS

For use with timber frame construction. The XHDT/K lintel must be used in conjunction with lateral restraint clips as shown, to prevent twisting. The XHDT/K range can be supplied to suit wider cavities: e.g. specify XHDT/K-70, XHDT/K-90. Lintels may be propped to facilitate speed of construction. See Lintel Installation on page 6.



**Lintel Hotlines**  
UK - 01283 200 150  
N.I - 028 8676 2184  
ROI - 048 8676 2184

Fax Back Enquiry Forms are available for download at [www.keystonelintels.com](http://www.keystonelintels.com)



# CAVITY WALL - TIMBER FRAME

Cavity widths 50-100mm

**OUTER LEAF  
102mm**

## T/K

For use with timber frame construction. The T/K lintel must be used in conjunction with lateral restraint clips and a tight fitting timber batten, as shown, to prevent twisting. The T/K range can be supplied to suit wider cavities: e.g. specify T/K-70, T/K-90. Lintels may be propped to facilitate speed of construction. See Lintel Installation guide on page 6.

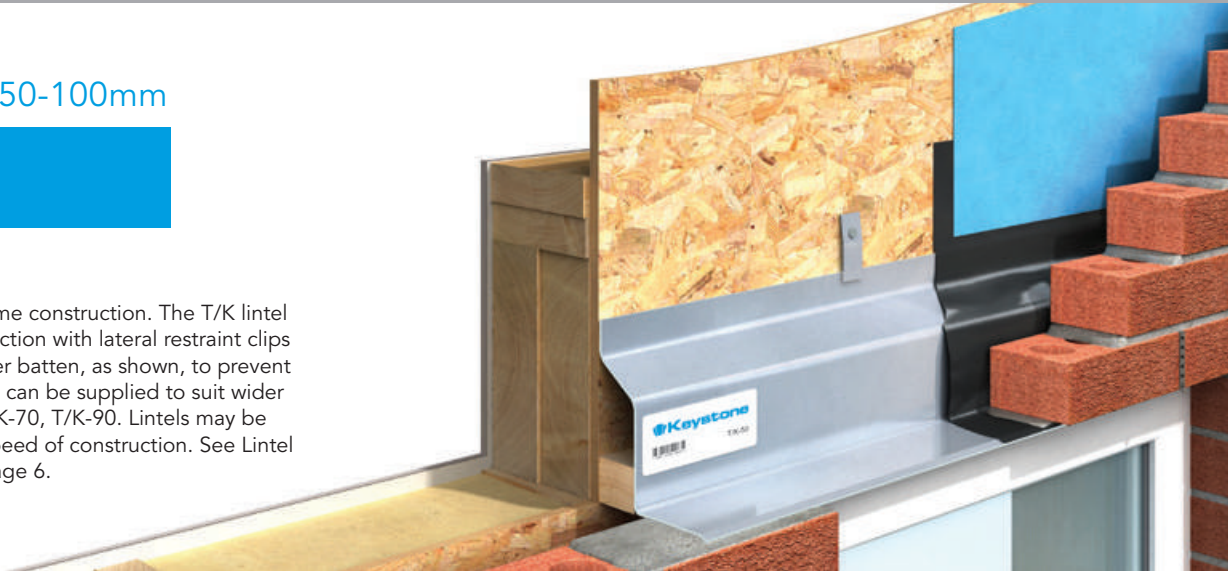

## Standard Load

### T/K-50 (For cavity widths 50 - 65mm)

Manufactured length 150mm increments	600- 1200	1350- 1800	1950- 2400	2550- 3600	3750- 4800
Height 'h'	110	110	135	175	250
Thickness	2.0	2.5	2.5	2.8	3.0
Total UDL kN	4	5	5	9	12

For installation please refer to installation notes on page 6.

### 50-65mm Cavity

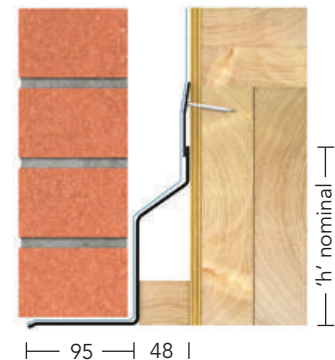

41

### T/K-70 & T/K-90

Manufactured length 150mm increments	600- 1650	1800- 2400	2550- 3000	3150- 4800
Height 'h'	118	170	204	260
Thickness	2.5	2.5	2.9	3.2
Total UDL kN	5	8	9	12

For installation please refer to installation notes on page 6.

### Specified Cavity Width

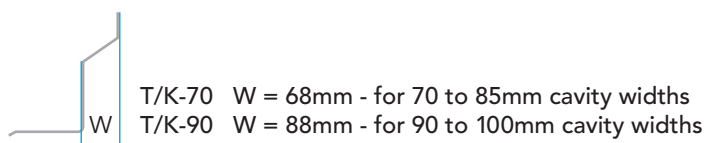
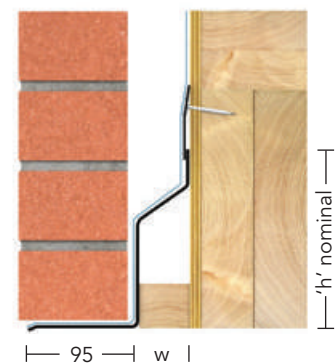

## CAVITY WALL - TIMBER FRAME

Available for cavity widths 50-100mm

**OUTER LEAF**  
**102mm**

### HDT/K

For use with timber frame construction. The HDT/K lintel must be used in conjunction with lateral restraint clips and a tight fitting timber batten, as shown, to prevent twisting. The HDT/K range can be supplied to suit wider cavities: e.g. specify HDT/K-70, HDT/K-90. Lintels may be propped to facilitate speed of construction. See Lintel Installation on page 6.



## Heavy Duty Load

42

### HDT/K-50 (For cavity widths 50-65mm)

Manufactured length 150mm increments	600- 1650	1800- 2400	2550- 3000
Height 'h'	163	202	260
Thickness	2.5	2.9	3.2
Total UDL kN	10	12	12

For installation please refer to installation notes on page 6.

### 50-65mm Cavity

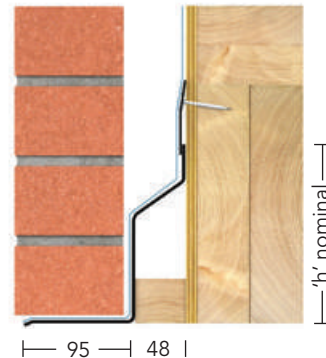

### HDT/K-70 & HDT/K-90

Manufactured length 150mm increments	600- 1650	1800- 2400	2550- 3000
Height 'h'	170	204	260
Thickness	2.5	2.9	3.2
Total UDL kN	10	12	12

For installation please refer to installation notes on page 6.

### Specified Cavity Width

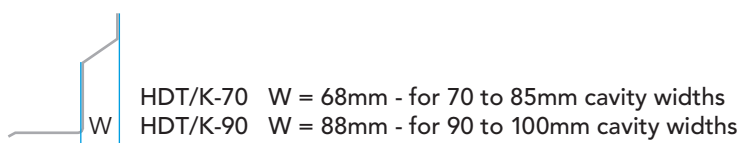
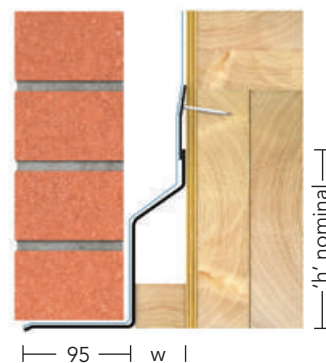

# 8

## SOLID WALL SINGLE LEAF LINTELS

Range  
102mm Single Leaf

### Standard Load

#### SB/K

Manufactured length 150mm increments	600- 1200	1350- 1800	1950- 2700
Height 'h'	60	110	210
Thickness	3.0	3.0	3.0
Total UDL kN	4	8	10

Longer lengths available.

Used to support the outer leaf of cavity wall construction. The SB/K can be supplied with no top bend (Specify ANG-K). Lintels may be propped to facilitate speed of construction. See Lintel Installation on page 6.

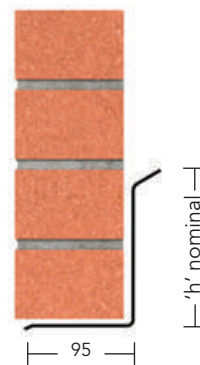

43

### Heavy Duty Load

#### SL/K

Manufactured length 150mm increments	600- 1800	1950- 2400	2550- 3000
Height 'h'	150	225	225
Thickness	2.5	2.5	3.0
Total UDL kN	16	20	22

Longer lengths available.

For use to support single leaf or outer leaf cavity wall construction. To achieve loading figures, lintel must be built in with brickwork as shown. Lintels may be propped to facilitate speed of construction. See lintel installation on page 6.

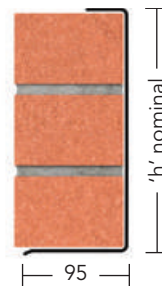
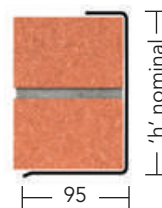

#### Lintel Hotlines

UK - 01283 200 150  
N.I - 028 8676 2184  
ROI - 048 8676 2184

Fax Back Enquiry Forms are available for download at [www.keystonelintels.com](http://www.keystonelintels.com)

# 9

## SOLID WALL BOX LINTELS

Range  
Wall Widths 100-215mm

Box lintels can be used for internal or external openings and with a variation of wall thicknesses. The Keystone box lintel has perforations along its length acting as a plaster key. As an optional extra Keystone box lintels can be insulated. The Keystone box lintel is designed to carry the full load of wet masonry as soon as it is installed

44

### INSTALLATION

Box Lintels must have a minimum end bearing of 150mm on each side of the opening, bedded on mortar. Level the lintel along its length and across its width. Masonry built must be laid on a mortar bed and all perpendicular joints to be filled with mortar.

Care should be taken to avoid shock loading on box lintels when used in conjunction with concrete floors or other heavy units.

### SPECIFICATION

For material specifications, please see page 5. Architectural specification clauses and full NBS plus specifications are available at [www.keystonelintels.com](http://www.keystonelintels.com)

### CODES AND REFERENCES

Code Ref	Wall Width
<b>BOX/K-75</b>	100mm
<b>BOX/K-100</b>	100mm
<b>BOX/K-150</b>	150mm
<b>BOX/K-200</b>	215mm

#### Lintel Hotlines

UK - 01283 200 150  
N.I - 028 8676 2184  
ROI - 048 8676 2184

Fax Back Enquiry Forms are available for download at [www.keystonelintels.com](http://www.keystonelintels.com)

### BOX/K-75

Manufactured length 150mm increments	600- 1650	1800
Height 'h'	75	75
Thickness	1.6	2.0
Total UDL kN	15	10

Used to support openings in 100mm wide walls.

### Standard Load

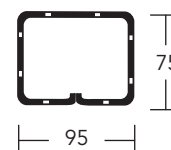

# SOLID WALL - BOX LINTELS

WALL WIDTHS  
**100mm-215mm**

## BOX/K-100

Used to support openings in 100mm wide walls. Lintels may be propped to facilitate speed of construction. See Installation on page 6.



## Standard Load

### BOX/K-100

Manufactured length 150mm increments	600- 1500	1650- 2100	2250- 2400	2550- 2700	2850- 3600	3750- 4200	4350- 4800
Height 'h'	75	150	150	150	215	215	215
Thickness	1.6	2.0	2.0	2.0	2.5	2.5	2.5
Total UDL kN	15	30	25	20	30	25	20

Used to support openings in 100mm wide walls.

### Standard Load

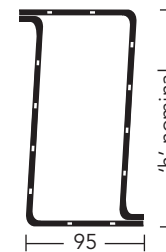

45

### BOX/K-150

Manufactured length 150mm increments	600- 1500	1650- 2100	2250- 2400	2550- 2700	2850- 3600	3750- 4200	4350- 4800
Height 'h'	150	150	150	150	215	215	215
Thickness	1.6	2.0	2.0	2.0	2.5	2.5	2.5
Total UDL kN	15	30	25	20	35	30	25

Used to support openings in 150mm wide walls.

### Standard Load

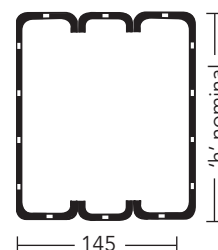

### BOX/K-200

Manufactured length 150mm increments	600- 1500	1650- 2100	2250- 2400	2550- 2700	2850- 3600	3750- 4200	4350- 4800
Height 'h'	150	150	150	150	215	215	215
Thickness	1.6	2.0	2.0	2.0	2.5	2.5	2.5
Total UDL kN	15	30	25	20	30	25	20

The flange of the BOX/K-200 is designed to support a nominal masonry load only up to a maximum of 3kN per metre run. Used to support openings in 215mm wide walls.

### Standard Load

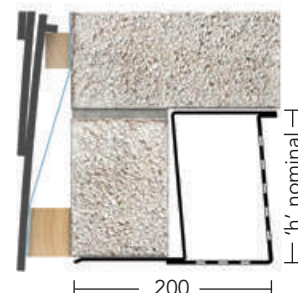

## SOLID WALL - BOX LINTELS

WALL WIDTHS  
**100mm-140mm**

### HD BOX/K

Can be insulated as an optional extra.  
Perforated steel for plaster key. Lintels may be propped to facilitate speed of construction.  
See Lintel Installation on page 6.



## Heavy Duty Load

46

### HD BOX/K-100

Manufactured length 150mm increments	600- 1200	1350- 1800	1950- 2400	2550- 2700
Height 'h'	150	150	215	215
Thickness	2.5	2.5	2.5	2.5
Total UDL kN	50	45	50	40

For heavy duty loading conditions to support concrete floors and point loads. Used to support internal and external openings in 100mm wide walls.

### Heavy Duty Load

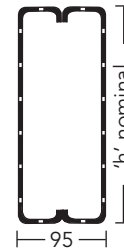

### HD BOX/K-150

Manufactured length 150mm increments	600- 1200	1350- 1800	1950- 2400	2550- 2700
Height 'h'	150	150	215	215
Thickness	2.5	2.5	2.5	2.5
Total UDL kN	50	45	50	40

For heavy duty loading conditions to support concrete floors and point loads. Used to support internal and external openings in 150mm wide walls.

### Heavy Duty Load

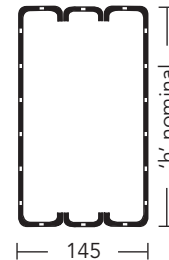

# SOLID WALL - BOX LINTELS

**WALL WIDTH  
215mm**

## HD BOX/K-200



## Heavy Duty Load

### HD BOX/K-200

Manufactured length 150mm increments	600- 1200	1350- 1800	1950- 2400	2550- 2700
Height 'h'	150	150	215	215
Thickness	2.5	2.5	2.5	2.5
Total UDL kN	40	35	45	40

The flange of the HD BOX/K-200 is designed to support a nominal masonry load only up to a maximum of 3kN per metre run. Used to support openings in 215mm wide walls.

### Heavy Duty Load

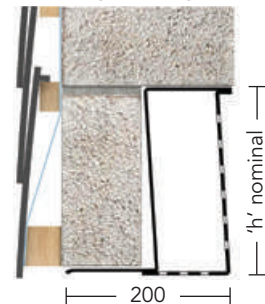

47

## BOX/K-200

This drawing illustrates how a BOX/K-200 Lintel can be used to support a 215mm leaf of solid stonework on the outer face of a traditional cavity wall.

The three dimensional image also illustrates how a DPC/Cavity Tray should be installed with this detail.

Cavity insulation omitted for clarity.



BOX/K-200 lintel shown with optional feature plate.

# 10

## SOLID WALL SOLID WALL LINTELS

Range  
Wall Widths 100-215mm

### Standard Load

48

#### INT/K-100

<b>Overall Length (mm)</b>	<b>900</b>	<b>1050</b>	<b>1100</b>	<b>1200</b>
<b>Maximum Span</b>	700	850	900	1000
<b>Total UDL kN</b>	7	7	7	7

When using INT/K-100 normal building practice should be observed in that one course and the mortar allowed to cure for at least 24 hours before additional loads are applied. Not suitable for floor loads.

#### SW/K-100

<b>Manufactured length 150mm increments</b>	<b>600-1200</b>	<b>1350-1650</b>	<b>1800-2100</b>	<b>2250-2700</b>
<b>Height 'h'</b>	55	86	86	113
<b>Thickness</b>	2.5	2.5	2.9	3.2
<b>Total UDL kN</b>	6	8	8	10

To achieve loading figures lintel must be built in as shown, blockwork must be tracked to accommodate upstand of lintel.

#### SW/K

<b>Manufactured length 150mm increments</b>	<b>600-1500</b>	<b>1650-1800</b>	<b>1950-2700</b>
<b>Height 'h'</b>	55	55	100
<b>Thickness</b>	2.5	3.0	3.0
<b>Total UDL kN</b>	6	6	10

To achieve loading figures lintel must be built in as shown. Lintels may be propped to facilitate speed of construction. See Lintel Installation on page 6.

#### Standard Load



Specify INT/K-64 for 75mm solid wall.



#### Standard Load



Suitable for 100 - 150mm solid walls.



#### Standard Load

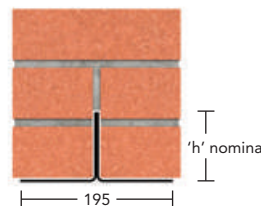

Suitable for 215mm solid walls.



#### Lintel Hotlines

UK - 01283 200 150  
N.I - 028 8676 2184  
ROI - 048 8676 2184

Fax Back Enquiry Forms are available for download at [www.keystonelintels.com](http://www.keystonelintels.com)



# SOLID WALL

**WALL WIDTH  
215mm**

## IB/K

To achieve loading figures lintel must be built in as shown. Lintels may be propped to facilitate speed of construction. See Lintel Installation on page 6.



## Heavy to Extreme Loads

### IB/K-2C

Manufactured length 150mm increments	600- 1800	1950- 3000
Height 'h'	152	152
Thickness	2.5	2.9
Total UDL kN	30	30

### Heavy Duty Load

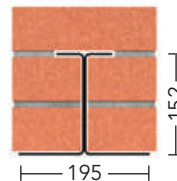

Suitable for  
215mm  
solid walls.



49

### IB/K-3C

Manufactured length 150mm increments	600- 1800	1950- 2100	2250- 3000	3150- 4000	4200- 4800
Height 'h'	227	227	227	227	227
Thickness	2.5	2.5	2.9	3.2	3.2
Total UDL kN	45	40	40	40	35

### Extra Heavy Duty Load

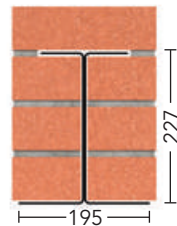

Suitable for  
215mm  
solid walls.



### IBX/K

Manufactured length 150mm increments	600- 4800	5200	5400	5800	6200	6600
Height 'h'	230	230	230	230	230	230
End Bearing	200	200	200	200	200	200
Total UDL kN	86	75	70	65	60	55

### Extreme Duty



Suitable for  
215mm  
solid walls.



# 11

## EXTENDED RANGE

- Roller Shutter
- Universal Arch
- Feature Plate Lintel
- Cant Brick Lintel
- Stepped Lintel
- Weep Vents & Stop Ends

### ROLLER SHUTTER LINTEL

50

Keystone's Roller Shutter Lintel is a unique and innovative lintel solution designed to incorporate a security shutter system with a structural lintel. Integrated into the fabric of the building Keystone's roller shutter lintel ensures unobtrusive and enhanced aesthetics with increased security.

The lintel design can cater for traditional, timber frame and off site modular construction. Popular applications include schools and colleges, health and welfare facilities, community and sport centres, commercial and prestige residential developments.

Upon request Keystone can supply CAD details of the specially developed roller shutter and can provide an extensive client support service.

- Fully insulated box around roller shutter
- Removable panel allows access to roller shutter for maintenance

When the shutter is in the raised position, the window or door opening looks no different from any other structural opening. In the lowered position, the system gives a secure barrier against intruder and vandalism attack.



Custom made designs such as those for curved and arched windows are also available.

Please note that Keystone supply the Roller Shutter Lintel only and not the cavity closer guides or shutter.

#### Dimension requirements:

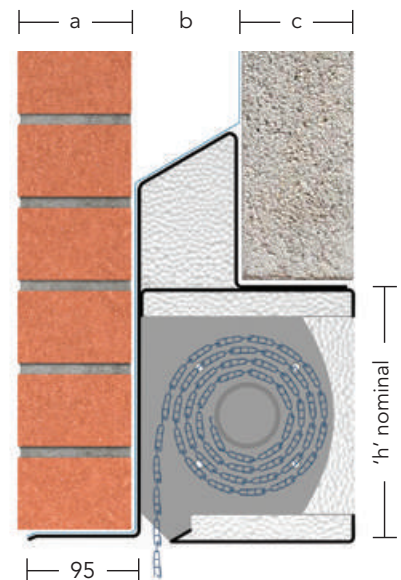
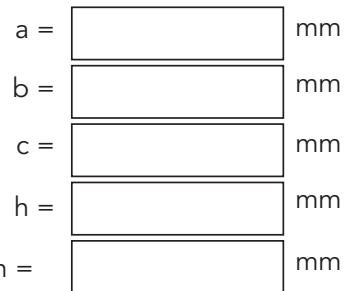

# EXTENDED RANGE

## UNIVERSAL ARCH

When low rise arches are required in brickwork above openings, the Keystone Universal Arch provides the ideal former for the bricklayer. Vacuum-formed from white pigmented impact resistant polystyrene.

Suitable for use in cavity walls and with timber frame construction, the unit is designed to sit on any steel lintel with an outer flange of 90mm to 95mm.

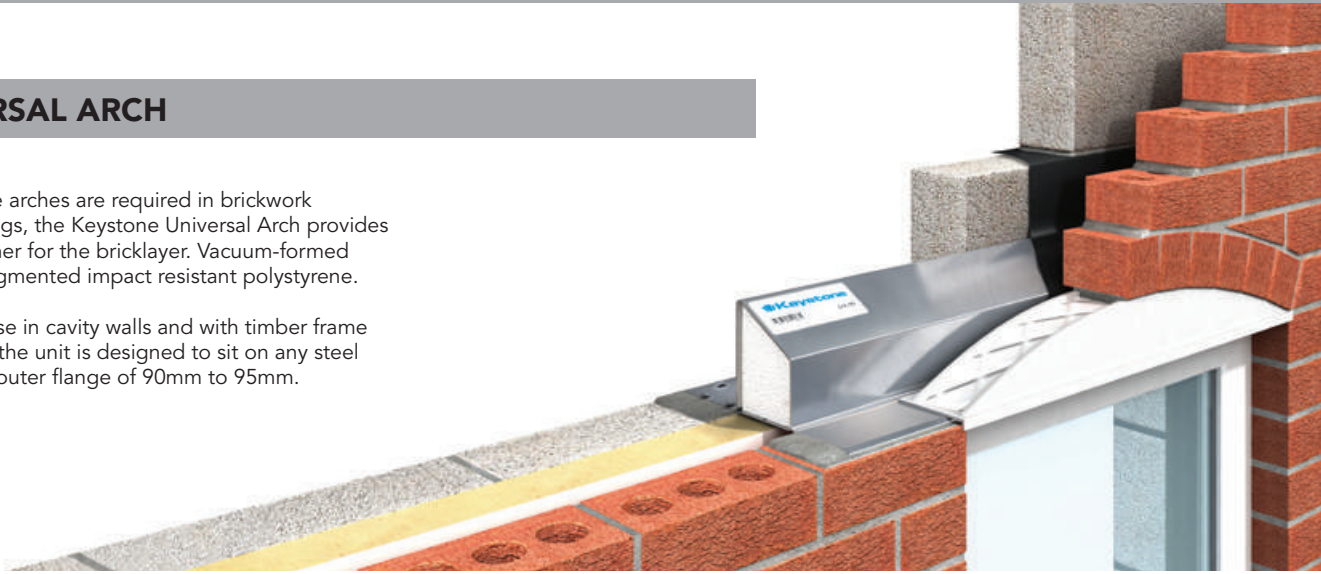

## Extended Lintel Range

### FEATURE PLATE LINTEL

A feature plate can be supplied on all lintel profiles to suit 50-165mm wide cavities.

Example specification:  
S/K-90 (FP)



### CANT BRICK LINTEL

The Cant brick Lintel can be supplied to suit all Lintel profiles for 50-165mm wide cavities.

Example specification:  
S/K-90 (CB 55/60mm)

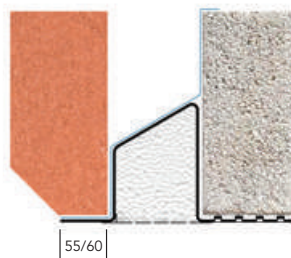

### STEPPED LINTEL

All cavity lintels in the Keystone range can be stepped to suit your requirements.

Example specification:  
S/K-90 (20mm step)

Standard step = 20mm  
Can be stepped to suit.

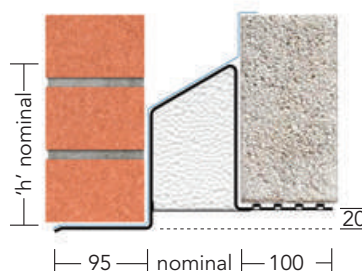

### UNIVERSAL ARCH SELECTOR

51

OPENING SIZES	NOMINAL ARCH SPAN	ARCH RISE	KEYSTONE REFERENCE
450-500	475	75	AB 475 P
600-650	625	75	AB 625 P
650-700	675	75	AB 675 P
700-750	725	75	AB 725 P
800-850	825	75	AB 825 P
900-950	925	75	AB 925 P
1000-1050	1025	75	AB 1025 P
1100-1150	1125	75	AB 1125 P
1200-1250	1225	75	AB 1225 P
1300-1350	1325	75	AB 1325 P
1450-1500	1475	75	AB 1475 P
1500-1550	1525	75	AB 1525 P
1600-1650	1625	75	AB 1625 P
1650-1700	1675	75	AB 1675 P
1750-1800	1775	75	AB 1775 P
1900-1950	1925	150	AB 1925 P
1950-2000	1975	150	AB 1975 P
2100-2150	2125	150	AB 2125 P
2200-2250	2225	150	AB 2225 P
2300-2350	2325	150	AB 2325 P
2400-2450	2425	150	AB 2425 P
2550-2600	2575	150	AB 2575 P
2700-2750	2725	150	AB 2725 P

## EXTENDED RANGE

### Weep Vents & Stop Ends

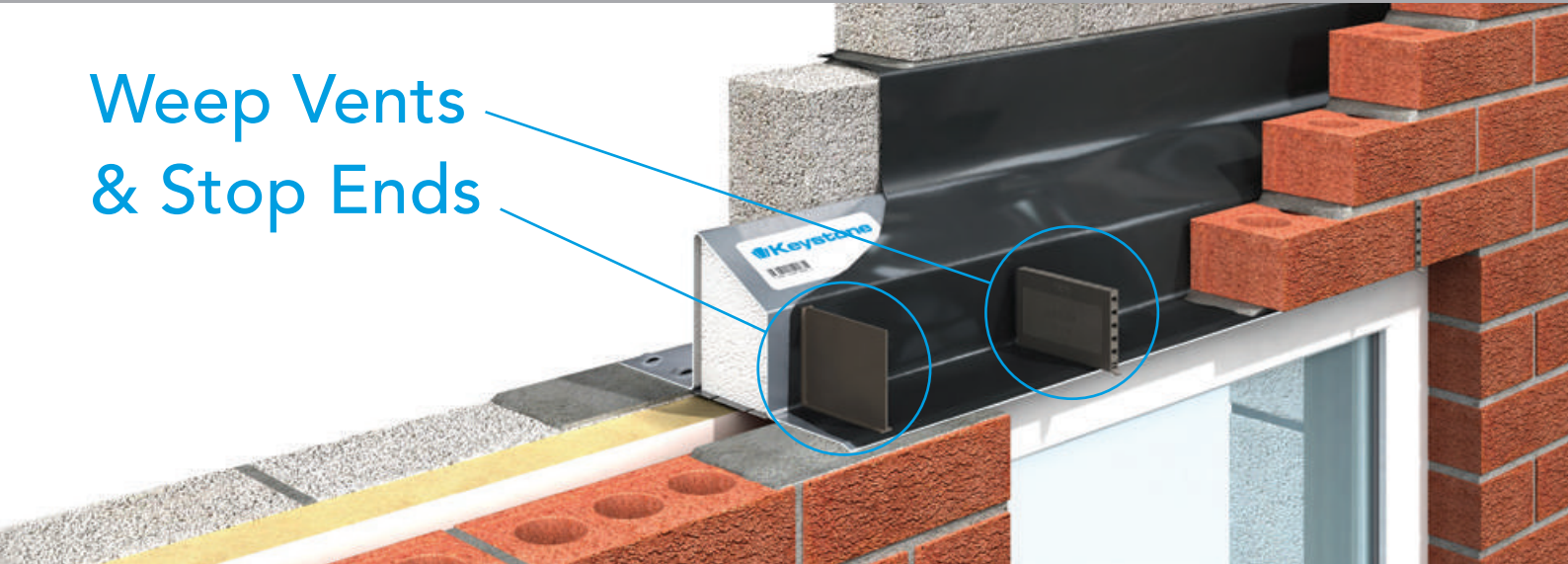

52

#### WEEP VENTS

Weep Vents create weep holes which are required over lintels to discharge collected water that may form at the window/door head. Each vent sits in the masonry perp end.

Keystone Weep Vents are positioned within the perp joints between masonry. Their function is two-fold:

- 1 They act as a weep to discharge water from DPCs, cavity trays and lintels.
- 2 They also act as ventilators to encourage the cavity to breathe.

Keystone Weep Vents also satisfy UK NHBC and Building Regulation requirements.

#### SIZES

49mm x 87mm x 9mm.  
Free airflow approximately  
300mm per unit



#### STOP ENDS

A Stop End is required at each end of a lintel to prevent moisture cascading over the ends into the cavity and onto the inside wall.

The use of Stop Ends quickly and economically introduce a lintel feature which removes the dangers that could occur with volumes of water being directed into the cavity.

#### STOP END SOLUTION

Keystone Stop Ends are available in two standard sizes. Stop Ends can be incorporated into the moulded base of the lintel by a butyl anchoring strip

enabling the Stop End to be secured towards the end of the lintels in the most appropriate position to suit the masonry perp joint. When fitted discharge from lintels is directed through brickwork weeps.

#### WHY STOP ENDS ARE USED?

The Building Research Establishment defect action sheet (DAS98) states "If Stop Ends are not used on cavity trays or lintels acting as cavity trays, rain water discharge particularly in cavity filled walls, may wet the inner leaf, producing dampness of internal walls."

Standard Stop End  
Specify KZ Stop



Hi-therm Stop End  
Specify KZ Hi-therm Stop



# 12 | STAINLESS STEEL LINTELS

The use of Stainless Steel is ideal when the life expectancy and maintenance programme of a building are key design considerations, for example in specialist laboratory or medical applications, hospitals, residential care homes, schools, prisons and institutional buildings. Stainless steel is suitable in these developments because of its outstanding anti-corrosion properties.

## PRODUCT INFORMATION

- All Keystone Stainless Steel Lintels are manufactured from Austenitic Stainless Steel, grade 304 2b to BS EN 10088-Part 2 Astm 240 (European Grade 1.4307).
- Upon request, other grades of stainless steel lintels are available.
- All Keystone loading tables apply to both Stainless Steel and Galvanised Steel lintels, subject to lintel width availability.
- All Keystone Stainless Steel lintels are made to order, specific to each application.
- All standard stainless steel lintels from Keystone are BBA approved.
- Special lintels are also available in Stainless Steel, made to order.

'British Standard Code of Practice for the use of masonry – part 3; Materials and Components' recommends the use of Stainless Steel Lintels in buildings that are subjected to aggressive environmental conditions and buildings exceeding three storeys.

There is also a requirement for NHBC registered projects to use Stainless Steel Lintels in coastal locations, namely, within 500m of the shoreline.

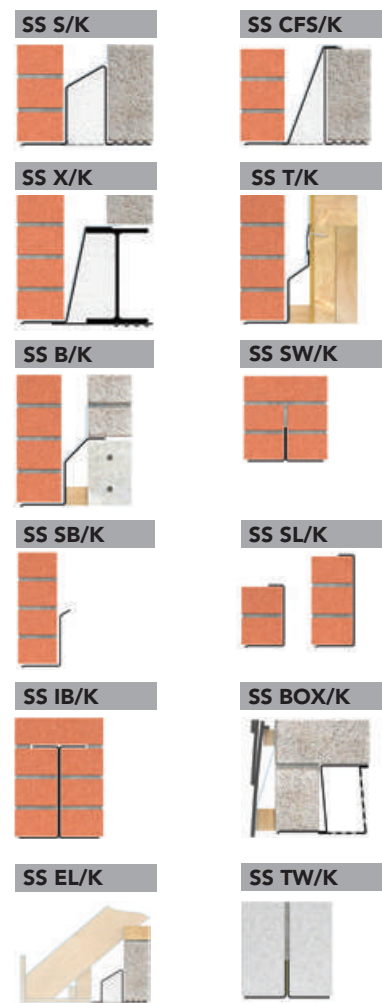

### Lintel Hotlines

UK - 01283 200 150  
N.I - 028 8676 2184  
ROI - 048 8676 2184

Fax Back Enquiry Forms are available for download at [www.keystonelintels.com](http://www.keystonelintels.com)

# Special Lintels

Special lintels provide the client and architect with a means to personalise a building's design. For over 20 years Keystone have been manufacturing special lintels for the construction industry, helping to make buildings that little bit more special.

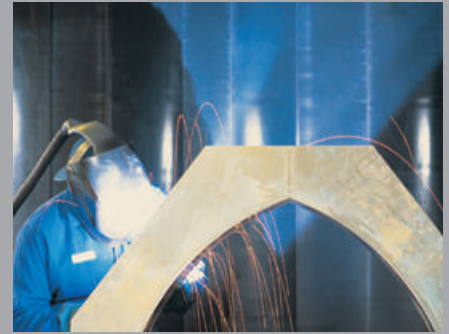

## CUSTOM MADE LINTEL SPECIALS

A Keystone special lintel is ideal when something bespoke is required, whether to provide a unique building feature, or to carry an unusual loading condition. With a dedicated team of engineers, Keystone assesses the

loading conditions and then designs the structural lintels, tailor made to the requirements and constraints of the individual project, in the most cost effective manner.

From parabolic, segmental, gothic and full arch lintels, bows, bays, corners and sun-lounge lintels the sky is the limit with Keystone's Special Lintel range.

54

## Square Bay Lintels

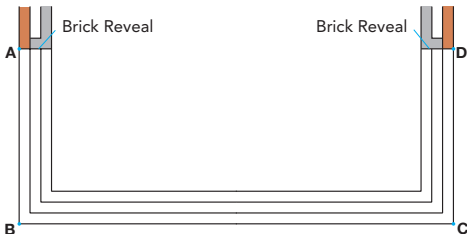
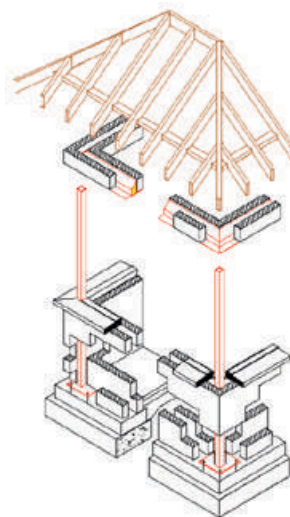
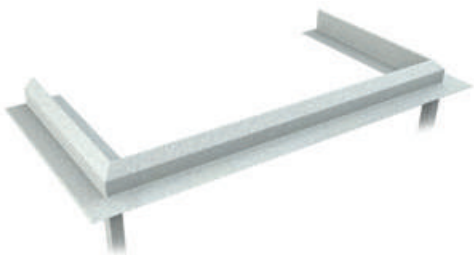

### DIMENSIONS REQUIRED

#### Lintel Dimensions

A to B =	mm
B to C =	mm
C to D =	mm

#### PLASTER KEY REQUIRED (Please Tick)

Inside only	<input type="checkbox"/>
Both sides	<input type="checkbox"/>
None	<input type="checkbox"/>

#### WALL CONSTRUCTION

Outer Leaf	mm
Cavity Width	mm
Inner Leaf	mm

#### SUPPORT POST

Height	mm
--------	----

**IMPORTANT NOTE:** Do not allow for bearing, this will be added at manufacturing stage. Very accurate measurements required.

# Full Arch Lintel

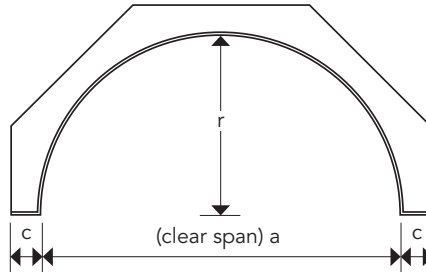

## DIMENSIONS REQUIRED

### Lintel Dimensions

Clear Span (a)	mm
Radius (r)	mm
End Bearing (c)	mm

### PLASTER KEY REQUIRED (Please Tick)

Inside only	
Both sides	
None	

### WALL CONSTRUCTION

Outer Leaf	mm
Cavity Width	mm
Inner Leaf	mm

### IMPORTANT NOTE:

Very accurate measurements required.

# Segmental Arch Lintel

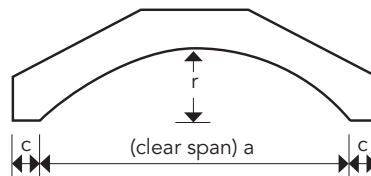
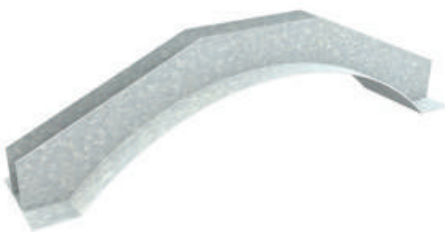

## DIMENSIONS REQUIRED

### Lintel Dimensions

Clear Span (a)	mm
Rise (r)	mm
End Bearing (c)	mm

### PLASTER KEY REQUIRED (Please Tick)

Inside only	
Both sides	
None	

### WALL CONSTRUCTION

Outer Leaf	mm
Cavity Width	mm
Inner Leaf	mm

### IMPORTANT NOTE:

Very accurate measurements required.

# Parabolic Arch Lintel

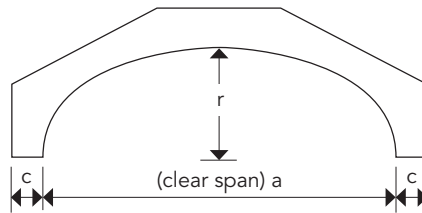

## DIMENSIONS REQUIRED

### Lintel Dimensions

Clear Span (a)	mm
Rise (r)	mm
End Bearing (c)	mm

### PLASTER KEY REQUIRED (Please Tick)

Inside only	
Both sides	
None	

### WALL CONSTRUCTION

Outer Leaf	mm
Cavity Width	mm
Inner Leaf	mm

### IMPORTANT NOTE:

Very accurate measurements required.

# Venetian Arch Lintel

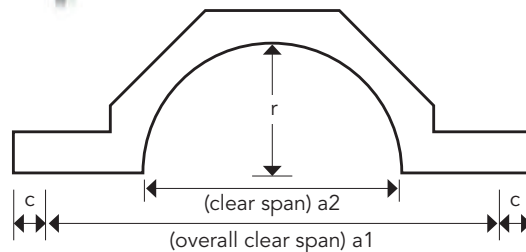

## DIMENSIONS REQUIRED

### Lintel Dimensions

Overall Clear Span (a1)	mm
Clear Span (a2)	mm
Rise (r)	mm
End Bearing (c)	mm

### PLASTER KEY REQUIRED (Please Tick)

Inside only	
Both sides	
None	

### SUPPORT POST (if required)

Height	mm
--------	----

### WALL CONSTRUCTION

Outer Leaf	mm
Cavity Width	mm
Inner Leaf	mm

### Arch type please tick

<input type="checkbox"/> Full	<input type="checkbox"/> Segmental	<input type="checkbox"/> Parabolic	<input type="checkbox"/> Apex	<input type="checkbox"/> Gothic
-------------------------------	------------------------------------	------------------------------------	-------------------------------	---------------------------------

### IMPORTANT NOTE:

Very accurate measurements required.



# Apex & Half Apex Lintel



Apex Lintel

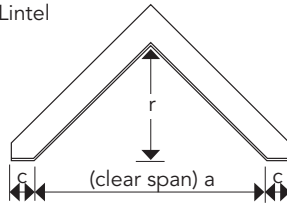

Half Apex Lintel

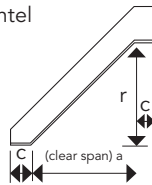

## DIMENSIONS REQUIRED

### Lintel Dimensions

Clear Span (a)	mm
Rise (r)	mm
End Bearing (c)	mm

### PLASTER KEY REQUIRED (Please Tick)

Inside only	
Both sides	
None	

### WALL CONSTRUCTION

Outer Leaf	mm
Cavity Width	mm
Inner Leaf	mm

### IMPORTANT NOTE:

Very accurate measurements required.

# Gothic Arch Lintel

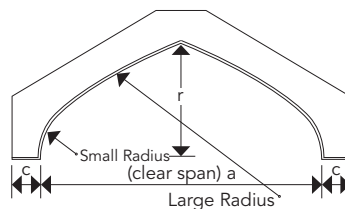
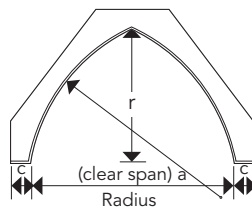

## DIMENSIONS REQUIRED

### Lintel Dimensions

Clear Span (a)	mm
Rise (r)	mm
End Bearing (c)	mm

### RADIUS TYPE (Please Tick)

Single	
Double	

### SINGLE RADIUS (If known)

Radius	
--------	--

### DOUBLE RADIUS (If known)

Large Radius	
Small Radius	

### PLASTER KEY REQUIRED (Please Tick)

Inside Only	
Both Sides	
None	

### WALL CONSTRUCTION

Outer Leaf	mm
Cavity Width	mm
Inner Leaf	mm

### IMPORTANT NOTE:

Very accurate measurements required.

## Corner Lintel

### STANDARD/HEAVY DUTY CORNER LINTEL



The Keystone Corner Lintel is supplied as a 'one piece' fully mitred and welded / bolted structural unit for easy installation.

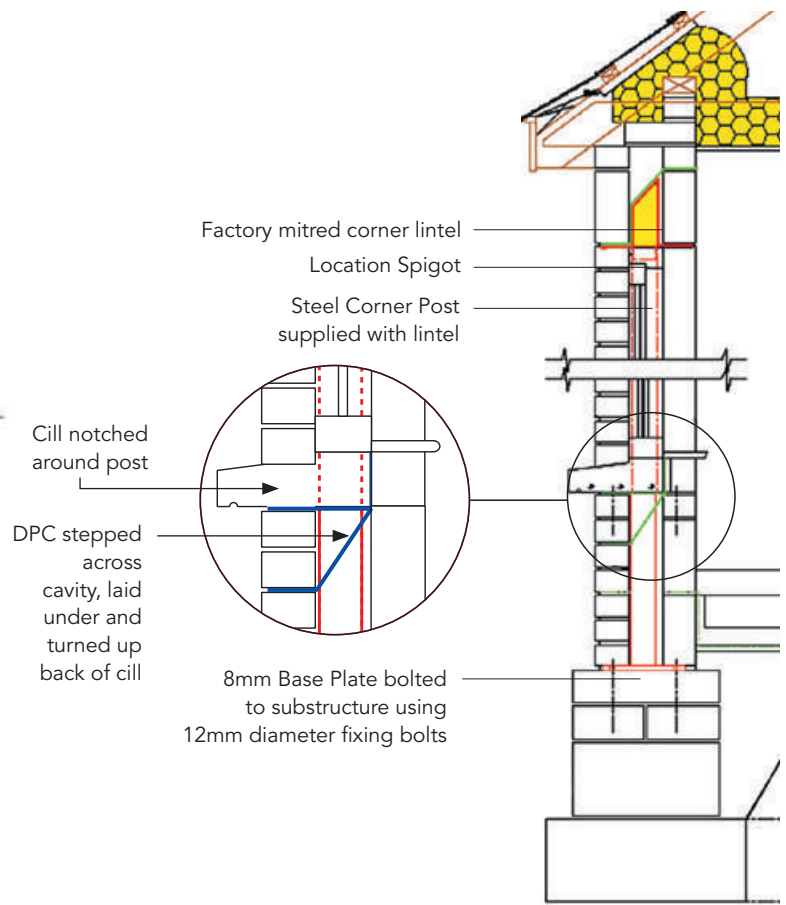

### EXTRA HEAVY DUTY CORNER LINTEL

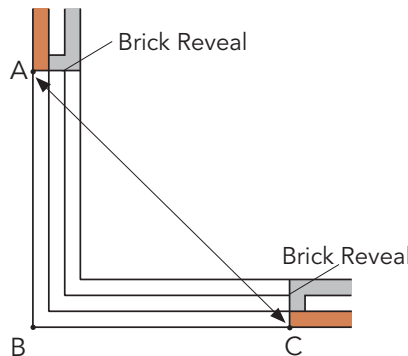
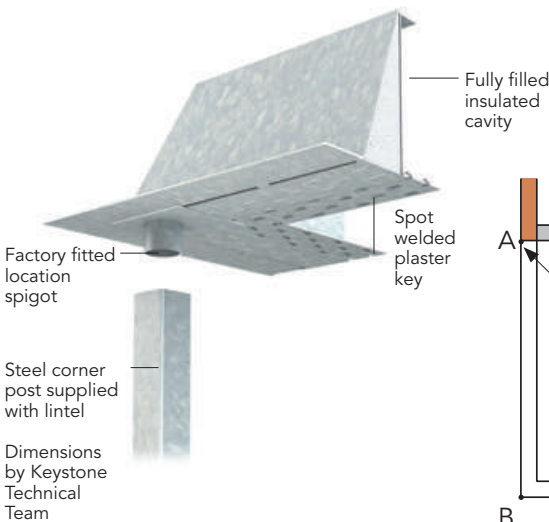

### DIMENSIONS REQUIRED

#### Lintel Dimensions

A to B =	mm
B to C =	mm
A to C =	mm

#### PLASTER KEY REQUIRED (Please Tick)

Inside only	<input type="checkbox"/>
Both sides	<input type="checkbox"/>
None	<input type="checkbox"/>

#### WALL CONSTRUCTION

Outer Leaf	mm
Cavity Width	mm
Inner Leaf	mm

#### SUPPORT POST

Height	mm
--------	----

**IMPORTANT NOTE:** Do not allow for bearing, this will be added at manufacturing stage. Very accurate measurements required.



# Bow Lintel



Bow Lintel with Projecting Reveals

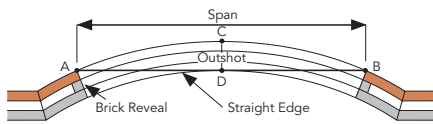

Bow Lintel with Non Projecting Reveals

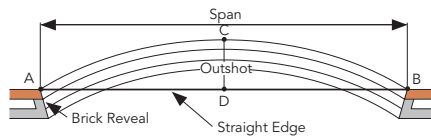

## DIMENSIONS REQUIRED

### Lintel Dimensions

A to B =	mm
C to D =	mm

### REVEALS (Please Tick)

Projecting	
Non-projecting	

### PLASTER KEY REQUIRED (Please Tick)

Inside only	
Both sides	
None	

### WALL CONSTRUCTION

Outer Leaf	mm
Cavity Width	mm
Inner Leaf	mm

### SUPPORT POST

Height	mm
--------	----

**IMPORTANT NOTE:** Do not allow for bearing, this will be added at manufacturing stage. Very accurate measurements required.

# Splayed Bay Lintel



Splayed Bay with Projecting Reveals

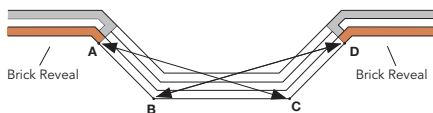

Splayed Bay with Non Projecting Reveals

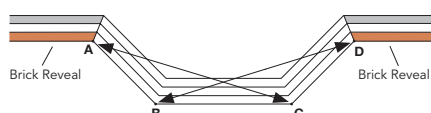

## DIMENSIONS REQUIRED

### Lintel Dimensions

A to B =	mm
B to C =	mm
C to D =	mm
A to D =	mm
A to C =	mm
B to D =	mm

### REVEALS (Please Tick)

Projecting	
Non-projecting	

### PLASTER KEY REQUIRED (Please Tick)

Inside only	
Both sides	
None	

### WALL CONSTRUCTION

Outer Leaf	mm
Cavity Width	mm
Inner Leaf	mm

### SUPPORT POST

mm	
----	--

**IMPORTANT NOTE:** Do not allow for bearing, this will be added at manufacturing stage. Very accurate measurements required.

## Sun Lounge Lintels

It is universally recognised amongst home owners and house builders that a sun lounge is a more practical, user friendly room than a conservatory. Furthermore, a sun lounge floor area can be included in the overall measurement of your house size, adding much more value to your home.



### WHAT DOES A SUN LOUNGE OFFER YOU?

A Sun Lounge Lintel is an easy way to add space at low cost when building a new house, or extending a property. An extra room rather than an add-on, a Sun Lounge is comfortable all year round while allowing you to watch the seasons come and go in comfort.

A Sun Lounge will blend with the existing appearance of your home. It is easy to construct, using materials similar to your house. Also, it adds genuine floor space, it is structurally sound and it adds value immediately.

### WHAT DO KEYSTONE OFFER?

The construction of a Sun Lounge has been simplified by the introduction of a Keystone Lintel. It is a one piece unit which eliminates the need for local engineering and allows architects to design the Sun Lounge to suit the property cost effectively.

The Keystone Sun Lounge Lintel is designed and delivered ready for erection.

### SUN LOUNGE OR CONSERVATORY?

A Sun Lounge is more competitively priced than a conservatory, is more visually appealing, is easier to clean, and is not a bolt on 'extra'.

- Much better heat retention in winter
- Protection from the summer sun
- Reduced noise compared to a conservatory roof



#### Lintel Hotlines

UK - 01283 200 150

N.I - 028 8676 2184

ROI - 048 8676 2184

Fax Back Enquiry Forms are available for download at [www.keystonelintels.com](http://www.keystonelintels.com)

# Standard Sun Lounge Lintel

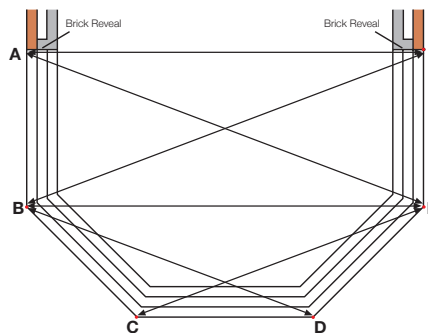
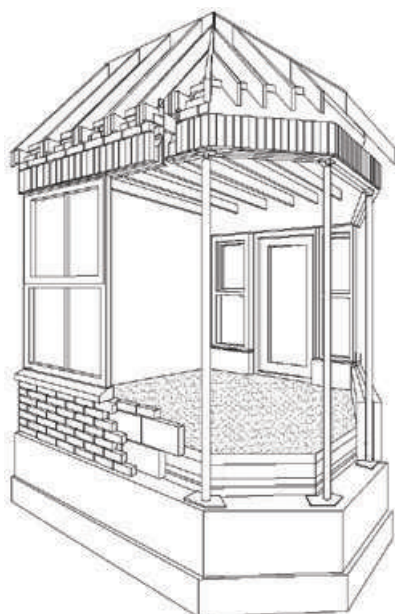
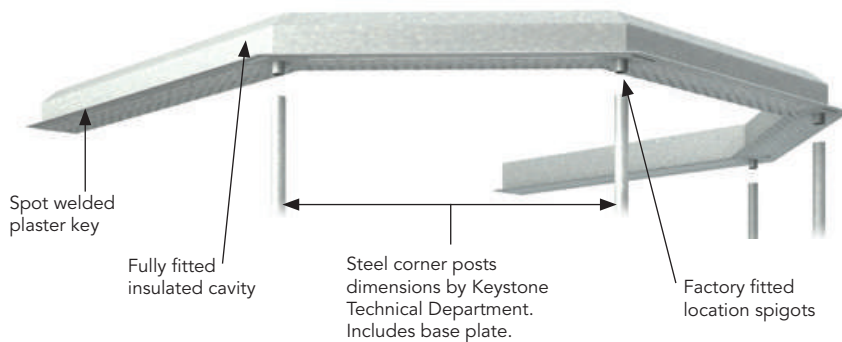

## DIMENSIONS REQUIRED

### Lintel Dimensions

A to B =	mm
B to C =	mm
C to D =	mm
D to E =	mm
E to F =	mm
A to F =	mm
A to E =	mm
B to F =	mm
B to E =	mm
C to E =	mm
B to D =	mm

### PLASTER KEY REQUIRED (Please Tick)

Inside only	<input type="checkbox"/>
Both sides	<input type="checkbox"/>
None	<input type="checkbox"/>

### WALL CONSTRUCTION

Outer Leaf	mm
Cavity Width	mm
Inner Leaf	mm

### SUPPORT POST

Height	mm
--------	----

## STANDARD SIZES

Sun Lounge	Internal Width	Internal Length
Type A	3 metres	3 metres
Type B	3 metres	3.6 metres
Type C	3.6 metres	3.6 metres
Type D	3.6 metres	4 metres
Type E	4 metres	4 metres
Type F	4 metres	4.6 metres

### MAKING IT EASY

The sun lounge lintel can be supplied in any size to suit your requirements. FASTRACK AutoCAD files can be downloaded from our website at: [www.keystonelintels.com/autocad](http://www.keystonelintels.com/autocad)



## Apex Sun Lounge Lintel

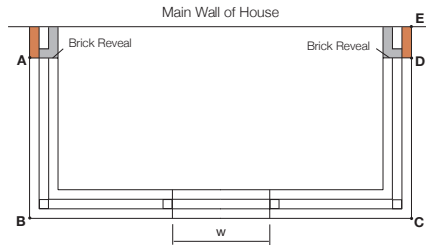

### DIMENSIONS REQUIRED

#### Lintel Dimensions

A to B =	mm
B to C =	mm
C to D =	mm
C to E =	mm

#### OTHER DIMENSIONS

Height from top of substructure to underside of lintels (H)	mm
External frame width of patio doors if applicable (W)	mm
Roof pitch	mm

**IMPORTANT NOTE:** Do not allow for bearing, this will be added at manufacturing stage. Very accurate measurements required.

## Venetian Sun Lounge Lintel

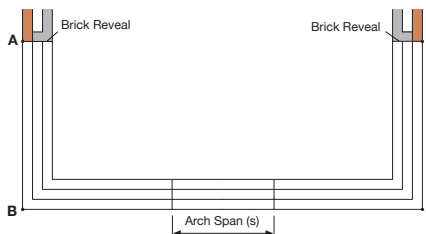

### DIMENSIONS REQUIRED

#### Lintel Dimensions

A to B =	mm
B to C =	mm
C to D =	mm

#### ARCH DIMENSIONS

Arch Span (s) =	mm
Rise (r) =	mm

#### SUPPORT POST

Height	mm
--------	----

#### SUN LOUNGE ARCH TYPE

Description	
-------------	--

#### PLASTER KEY REQUIRED (Please Tick)

Inside only	
Both sides	
None	

#### WALL CONSTRUCTION

Outer Leaf	mm
Cavity Width	mm
Inner Leaf	mm

**IMPORTANT NOTE:** Do not allow for bearing, this will be added at manufacturing stage. Very accurate measurements required.

# Bow Sun Lounge Lintel

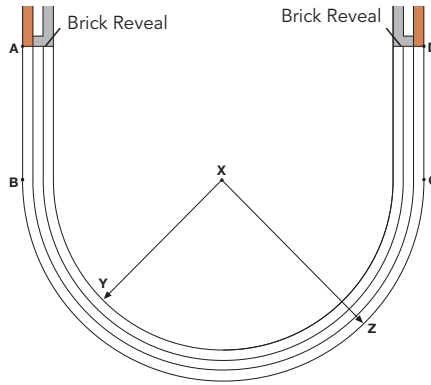
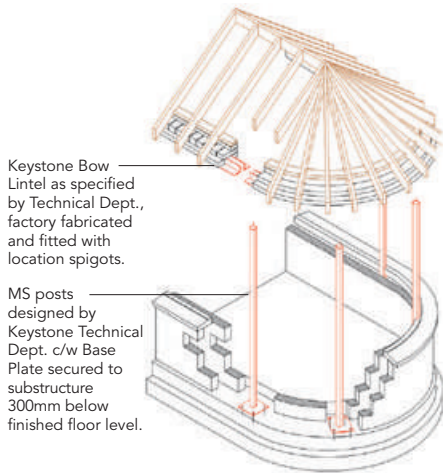

## DIMENSIONS REQUIRED

### Lintel Dimensions

A to B =	mm
B to C =	mm
C to D =	mm
X to Y =	mm
X to Z =	mm

### SUPPORT POST

Height	mm
--------	----

### PLASTER KEY REQUIRED (Please Tick)

Inside only	<input type="checkbox"/>
Both sides	<input type="checkbox"/>
None	<input type="checkbox"/>

### WALL CONSTRUCTION

Outer Leaf	mm
Cavity Width	mm
Inner Leaf	mm

**IMPORTANT NOTE:** Do not allow for bearing, this will be added at manufacturing stage. Very accurate measurements required.

# Square Bay Sun Lounge Lintel

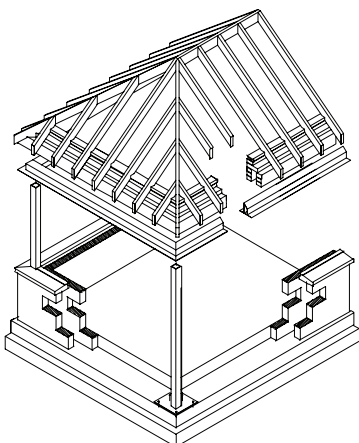
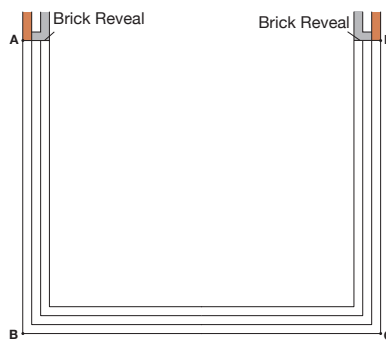
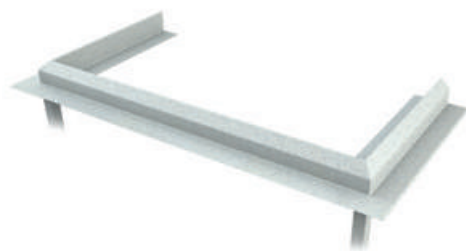

## DIMENSIONS REQUIRED

### Lintel Dimensions

A to B =	mm
B to C =	mm
C to D =	mm

### PLASTER KEY REQUIRED (Please Tick)

Inside only	<input type="checkbox"/>
Both sides	<input type="checkbox"/>
None	<input type="checkbox"/>

### WALL CONSTRUCTION

Outer Leaf	mm
Cavity Width	mm
Inner Leaf	mm

### SUPPORT POST

Height	mm
--------	----

**IMPORTANT NOTE:** Do not allow for bearing, this will be added at manufacturing stage. Very accurate measurements required.

# Standard Sun Lounge Construction Data

## CONSTRUCTION DETAILS

Provide 150mm fibreglass quilt insulation between roof rafters and collar ties. Insulation to be carried over top of cavity wall and pushed into soffit box to prevent a cold bridge. Install Cullen G400 eaves ventilators to provide a continuous air path for roof space ventilation between roof and insulation and roof underlay at eaves equivalent to 10,000mm<sup>2</sup>/m<sup>2</sup> with Cullen G1200 over fascia ventilator to provide ventilation to roof space equivalent 10,000mm<sup>2</sup>/m<sup>2</sup> in accordance with Building Regs. Approved Document F and or BS 5250: 2011. Fixed in accordance with manufacturers instructions.

Provide stepped cavity tray across wall directly above Code No.4 flashing, where new roof abuts wall. Note all lead to be treated with patination oil. Rainwater goods fascia and soffit to match existing. RC cill with DPC @ rear, ends and under. Wall DPC located min. 150mm above ground level. 300mm solid blockwork footings.

250mm x 600mm concrete foundation. Form new opening from existing dwelling into Sun Lounge to client's requirements.

Provide vertical DPC where Sun Lounge window abuts existing wall. Where new wall abuts existing, new cavity to be continuous with existing cavity. Provide 35mm polystyrene insulation between MS post and against inner leaf where post is inside cavity, to prevent a cold bridge. All glazed panels to doors and side panels with glazing less than 1500mm above floor or ground level to be safety glass to BS6206: Class B and C.

Provide 300mm cavity wall construction with 60mm Rigid Polystyrene Insulation - Wall ties with insulation clips to be spaced 750mm horizontal and 450mm vertical CRS. Form new external steps @ doorway to comply with current Building Regs. Any new heating pipes to be insulated with an insulation of thickness of not less than the diameter of the pipe - insulation to BS 5422:2009.

Provide 100mm dia stormwater drain, laid to fall 1:60, drain pipe to be surrounded with 150mm pea gravel. All drain pipes to comply with BS 4660 - connected to existing system.

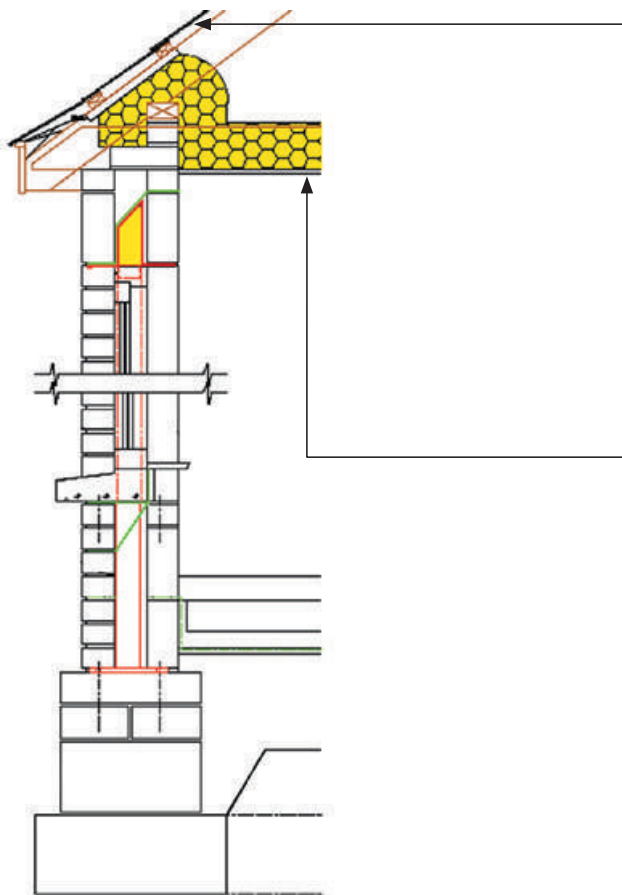

## ROOF CONSTRUCTION

Slates or tiles to match existing on 25 x 50mm battens on one layer sarking felt on 38 x 150mm rafters @ 400mm CRS with 38 x 50mm battens to U/S of rafters to maintain 50mm airgap within roof construction when incorporating 150mm fibre glass quilt insulation. 50 x 100mm Ridge Plate shot fixed to T/S ridge beam. 50 x 100mm Wall Plate securely strapped down to wall using 5 x 30mm galv ms straps by Cullen or equal @ 1200mm CRS. 100 x 25mm diagonal bracing positioned both sides of roof. 38 x 100mm collar ties @ 400mm CRS. 50 x 250mm hip rafters. TG and V redwood sheeting ceiling painted with Class 1 SSF varnish. All structural timber to be C16 or greater and must be stamped accordingly.

## STRUCTURAL RIGIDITY

- Roof Anchorage - First rafter and collar tie to be bolted to main wall at 450mm CRS using Rawl bolts or similar proprietary fixing.
- MS support posts and factory fitted Base Plate to be bolted down on top of solid footings built up to 300mm below finished floor level.
- Racking resistance provided using 9mm plywood secured to U/S of rafters and collar ties prior to any decorative finishes.
- Where a raised or vaulted ceiling is required a Keystone Ridge Beam Cradle must be used.



# Ridge Beam Cradle

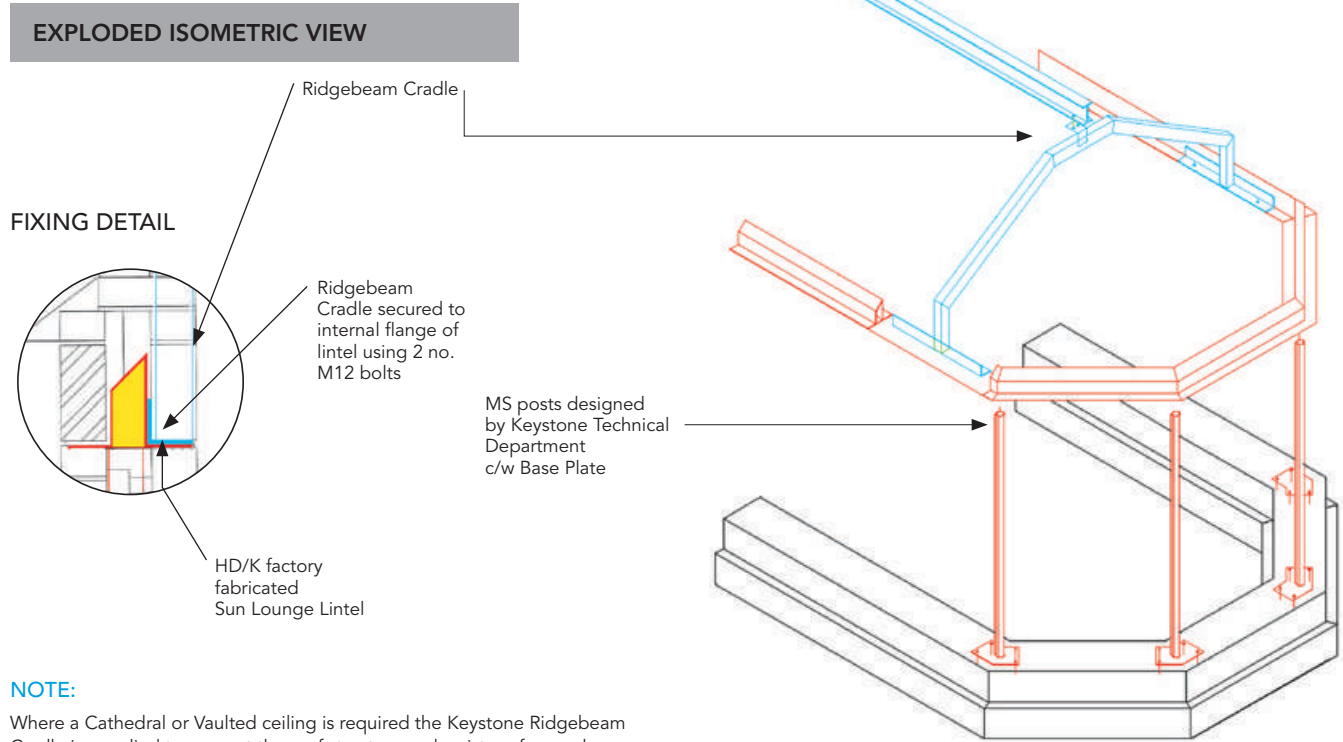

**NOTE:**

Where a Cathedral or Vaulted ceiling is required the Keystone Ridgebeam Cradle is supplied to support the roof structure and resist roof spread.

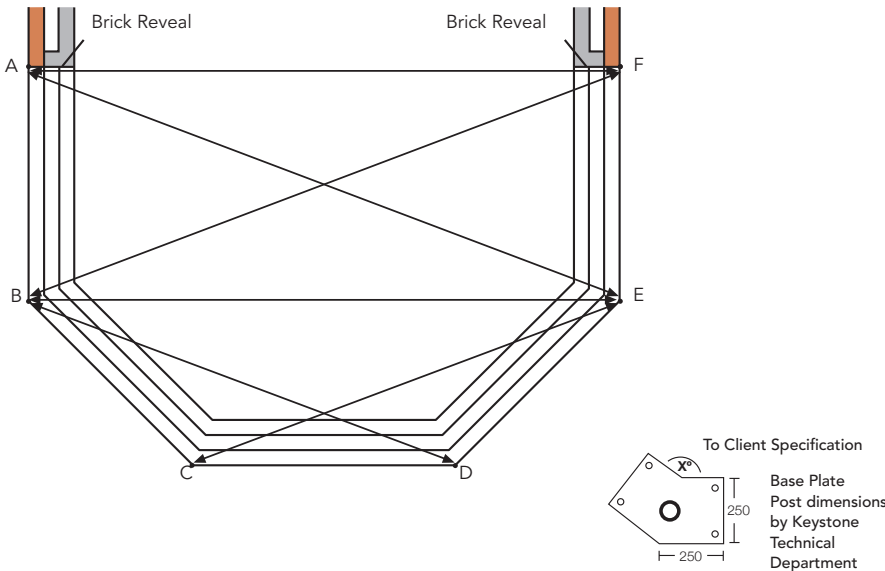

**DIMENSIONS REQUIRED**

**Lintel Dimensions**

A to B =	mm
B to C =	mm
C to D =	mm
D to E =	mm
E to F =	mm
A to F =	mm
A to E =	mm
B to F =	mm
B to E =	mm
C to E =	mm
B to D =	mm

**PLASTER KEY REQUIRED (Please Tick)**

Inside only	
Both sides	
None	

**WALL CONSTRUCTION**

Outer Leaf	mm
Cavity Width	mm
Inner Leaf	mm

**SUPPORT POST**

Height	mm
--------	----



## Brick Slip Feature Lintels

Keystone Brick Slip Feature Lintels are a one piece prefabricated unit, manufactured bespoke to order, achieving even the most challenging architectural designs.



### CUSTOM MADE BRICK SLIP FEATURE LINTELS

66

Keystone provide a technically advanced solution for an extensive range of brick slip installations including arches, panels, soffits and architectural features.

Produced offsite as a one piece prefabricated unit, the patented Keystone system ensures maximum performance thanks to the unique adhesion process

Keystone receive a consignment of the brick being used onsite. This brick is then tailored to suit the client's design and fixed to Keystone's galvanised and powder-coated structural steel elements. The finished Brick Slip Feature Lintel joins seamlessly with the already constructed brickwork.



### KEYSTONE BRICK SLIP FEATURE LINTEL BENEFITS

- Customised to your requirements
- Precision cut bricks
- Load bearing lintel
- Lightweight for fast build programmes
- Optional brick clad soffit
- Optional centre stone feature
- Optional Insulation

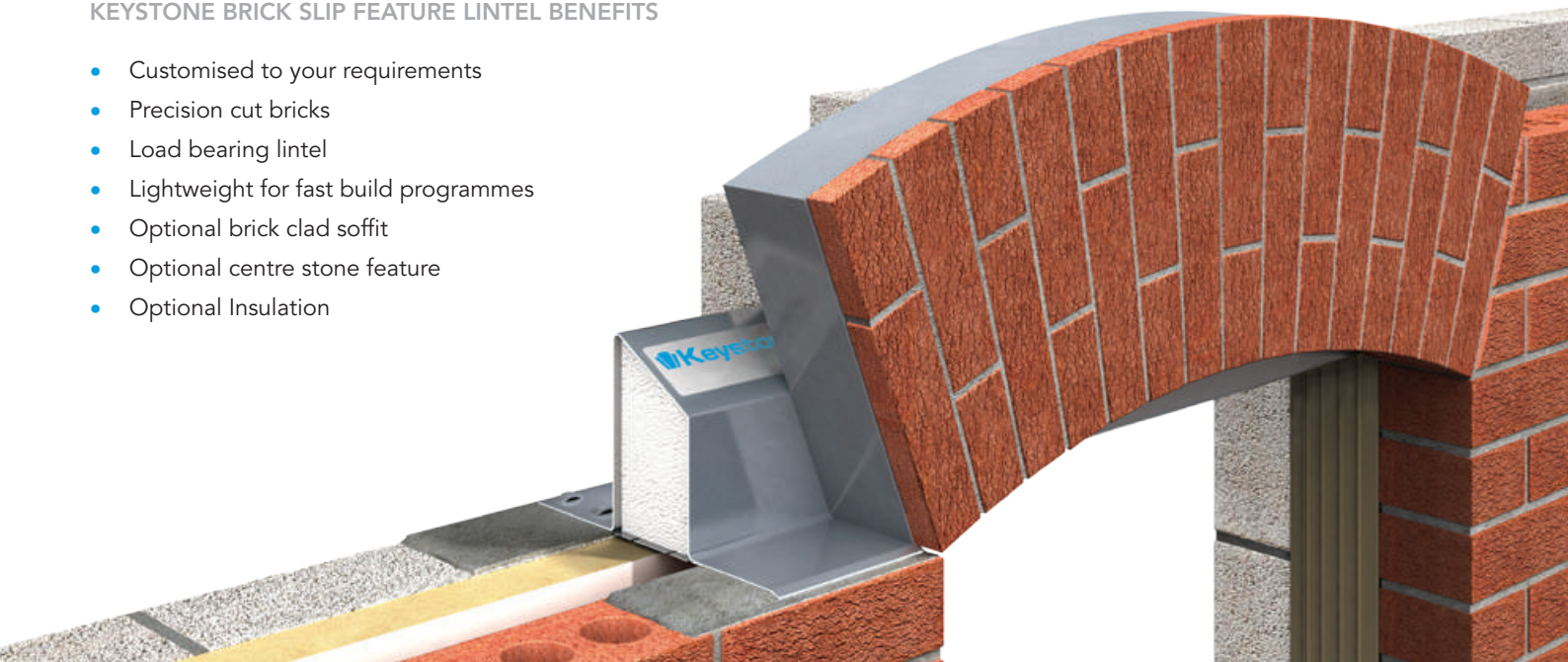

## Patented Brick Slip System

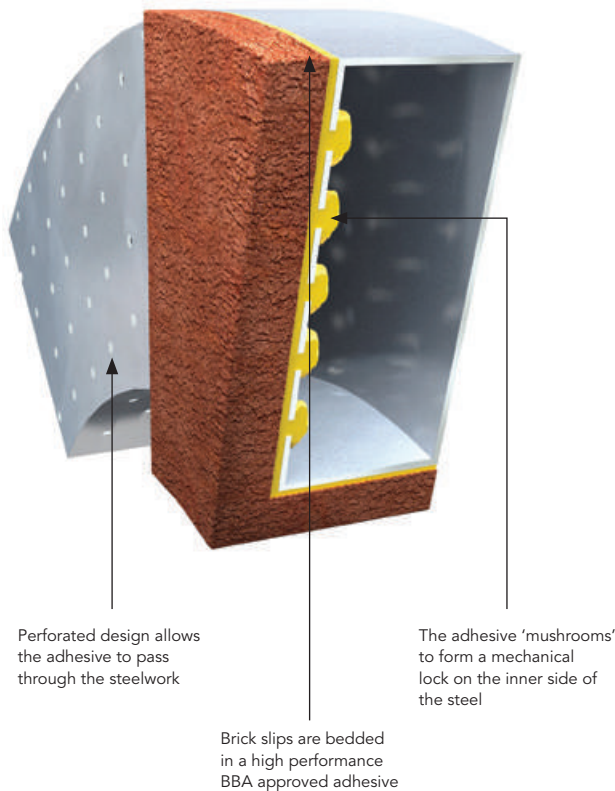

With thousands of installations completed over the past decade the system is a proven and reliable solution which provides maximum adhesion of the brick slips.

The patented design of the perforated steelwork interfaces with the adhesive allowing the adhesive to pass through and form a mushroom on the inside of the steel creating a physical lock.

Independent testing carried out by Ceram has verified that in destructive testing there were no failures in the steel / adhesive interface.

“Keystone provides a totally bespoke service for even the most complex brick slip project.”

67

### BRICK ADHESIVE

Keystone uses only specialist high performance adhesives designed primarily for the decorative brick industry which have been extensively tested and are BBA approved.

### CONTROLLED CONDITIONS

Keystone Brick Slip Feature Lintels are produced off-site in a factory environment which ensures that the bonding process occurs in optimum controlled conditions free from wet weather, extreme temperature and excessive dust.

### CERAM BUILDING TECHNOLOGY

Test report Number SW238/02

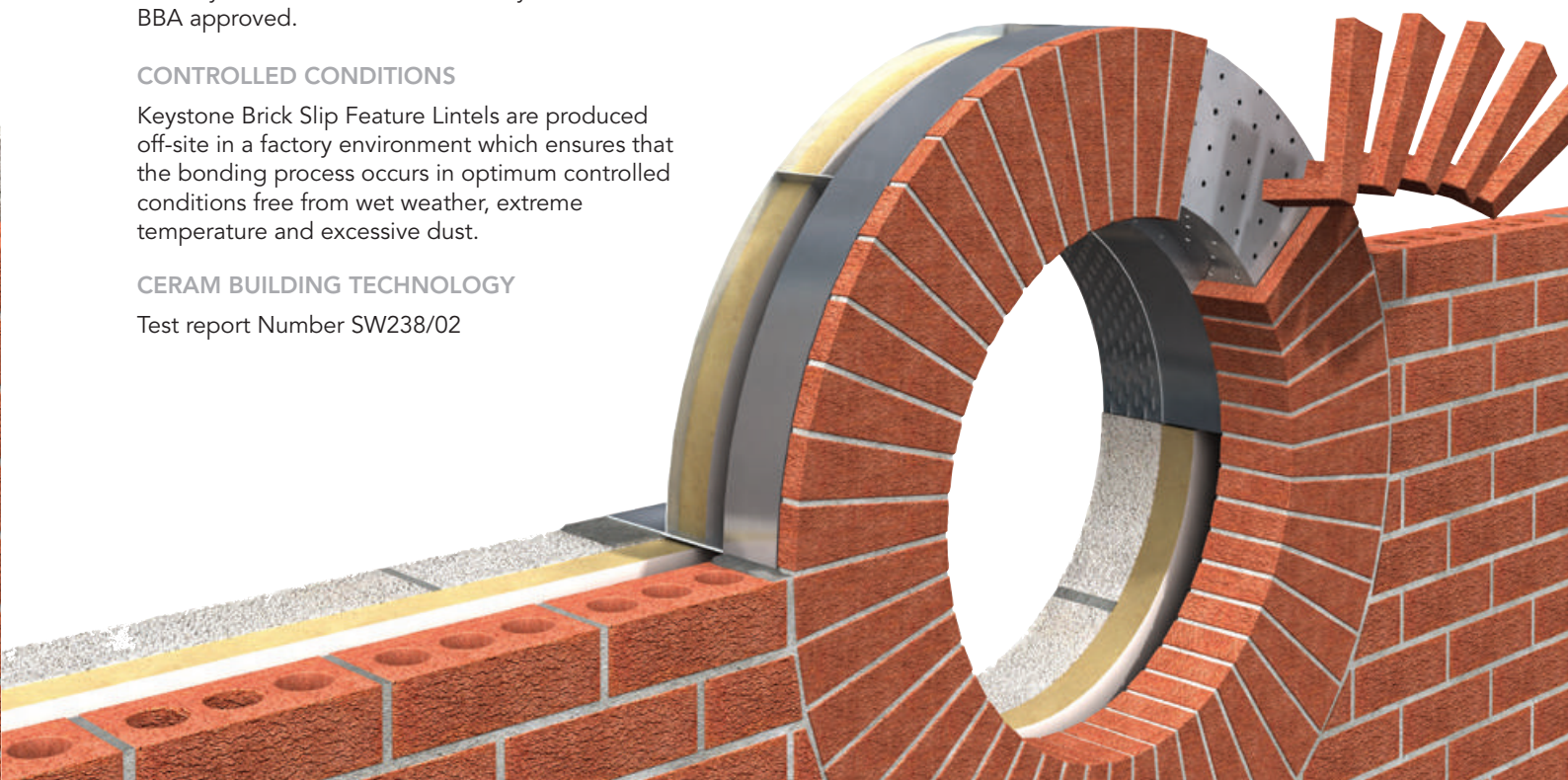

## Brick Slip Arch Solutions

Keystone specialises in producing brick slip arch solutions for both domestic and commercial applications. Arches of up to 12m span have been produced therefore eliminating the brick cutting process onsite.

KEYSTONE'S SEGMENTAL ARCH BRICK SLIP FEATURE LINTEL

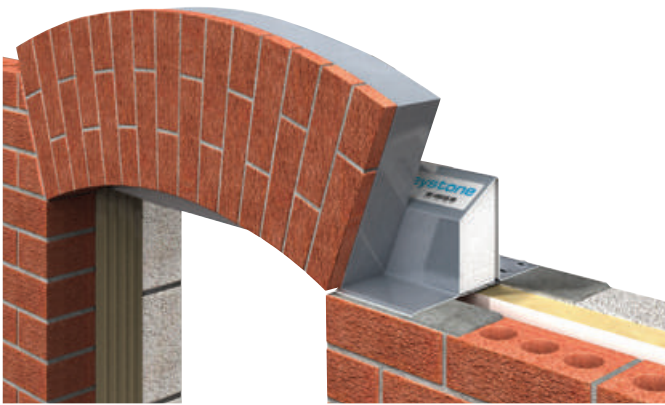

KEYSTONE'S FLAT ARCH BRICK SLIP FEATURE LINTEL

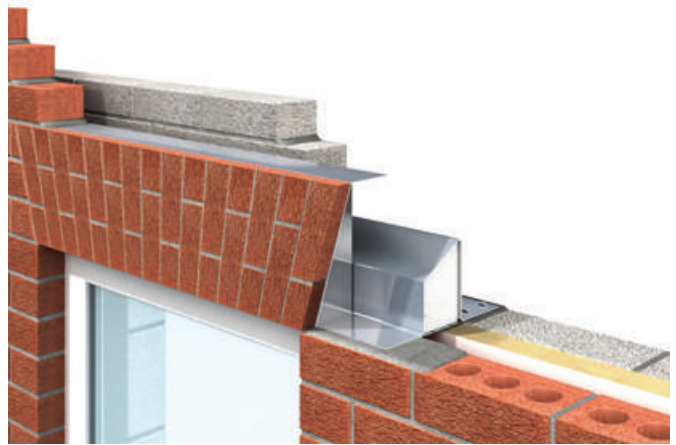

KEYSTONE'S GOTHIC ARCH BRICK SLIP FEATURE LINTEL



KEYSTONE'S PARABOLIC ARCH BRICK SLIP FEATURE LINTEL

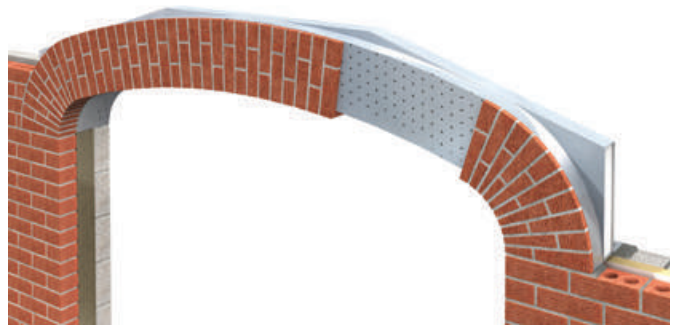

KEYSTONE'S FULL BULLSEYE ARCH BRICK SLIP FEATURE LINTEL

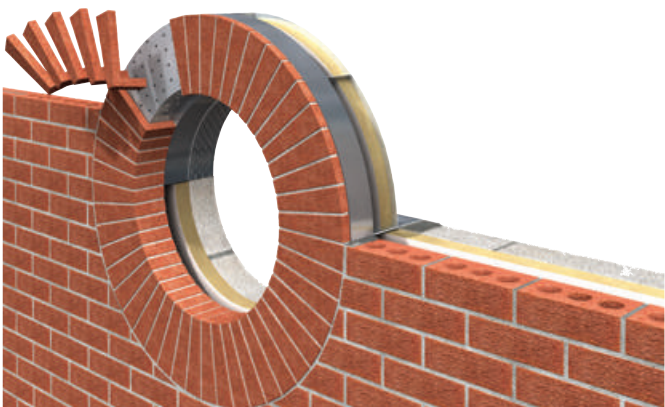

KEYSTONE'S APEX ARCH BRICK SLIP FEATURE LINTEL



# Brick Slip Soffit Solutions

Keystone offers a range of brick slip soffit solutions with a bespoke design and technical service.

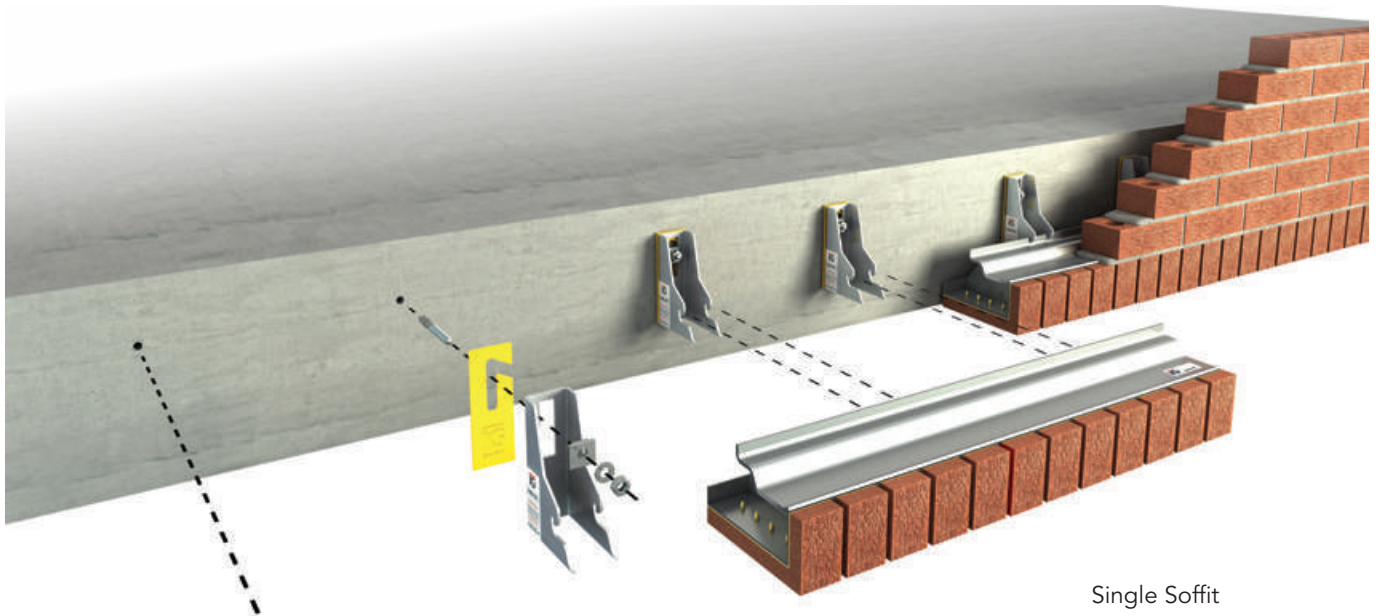

Single Soffit

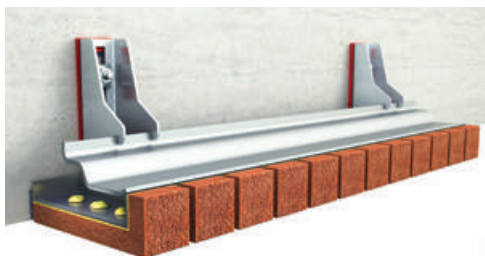

By combining our Keystone masonry support system with bespoke steel components we produce single and double sided soffit systems which are ideal for runs of any length.

This versatile approach can adapt to suit the particular building frame and in each case Keystone offer a highly practical solution onsite.

Soffit solutions utilise BD13 bricks with a faced base.

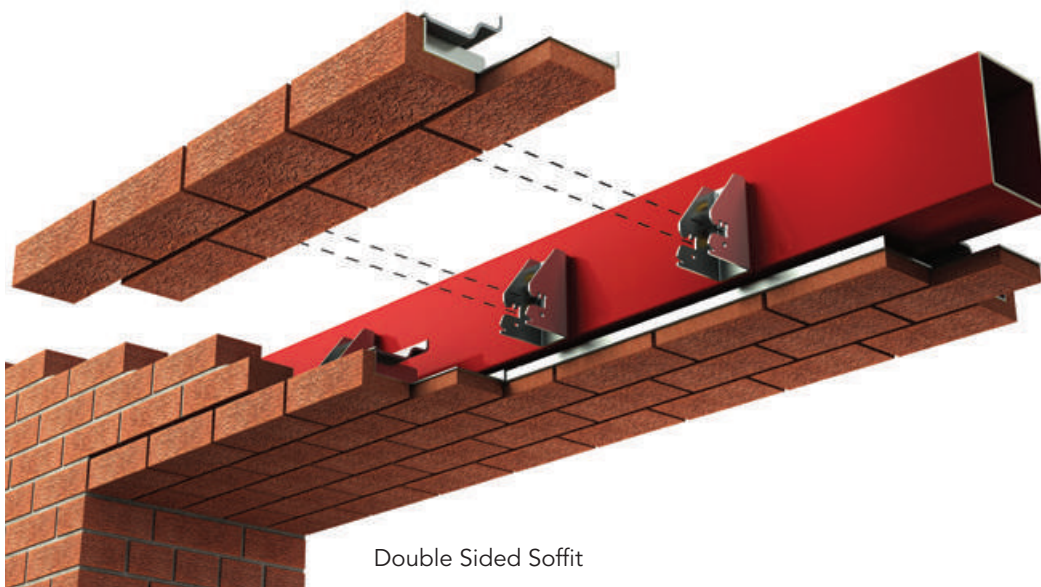

Double Sided Soffit

## Brick Slip Panel Solutions

Keystone's bespoke components use our patented adhesion system and are delivered to site as a complete unit ready for installation and final pointing.



### STEP 1

The brick slip panel is positioned, fixed and built into the outer skin.



### STEP 2

The brick slips are pointed to ensure a seamless appearance.

## Bespoke Brick Slip Solutions

Keystone designed and produced a totally bespoke solution for this complex brickwork project on new student accommodation at Liverpool University.

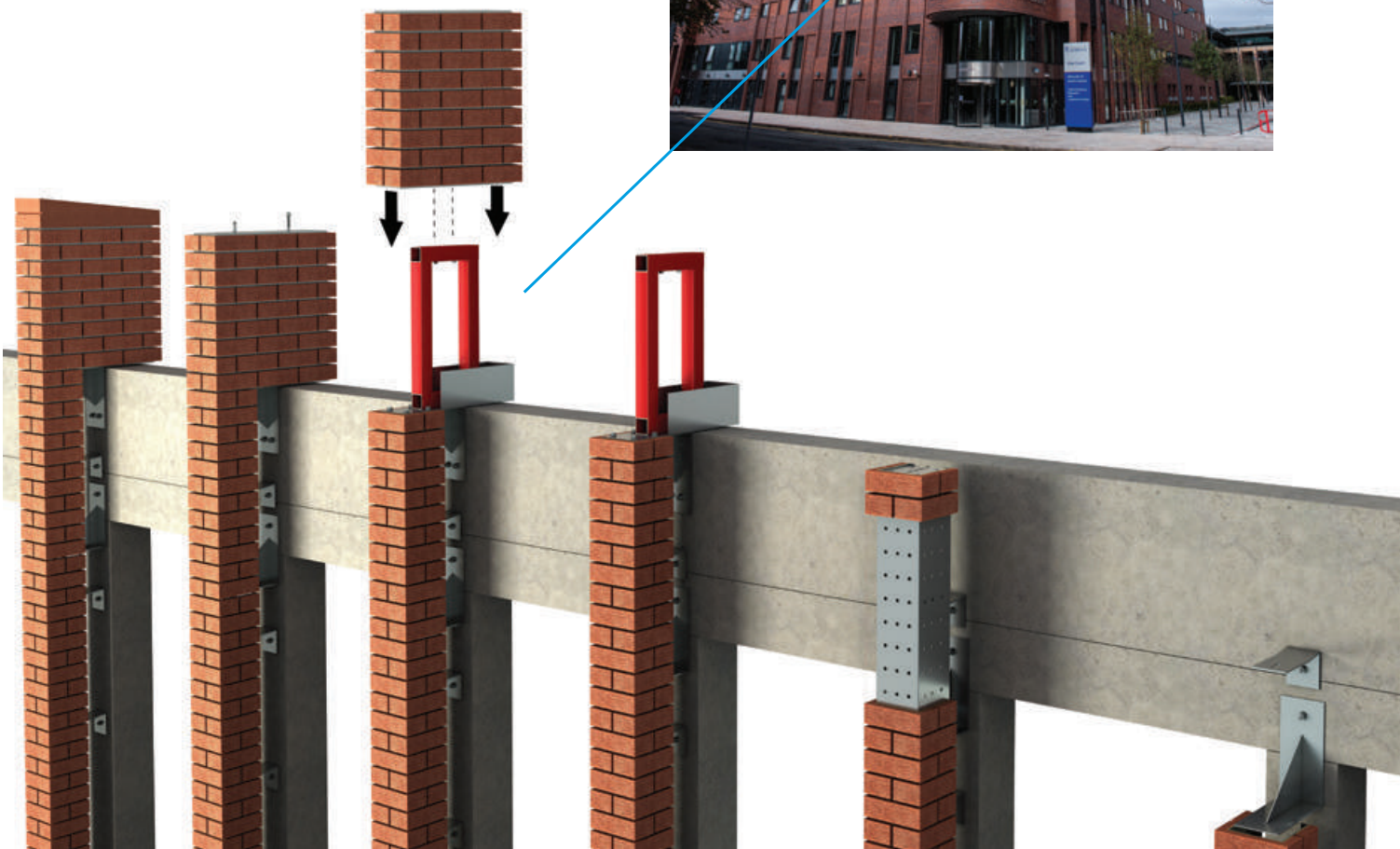

# Featured Brick Slip Projects

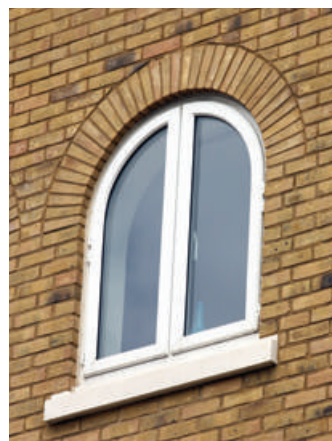

# Masonry Supports

## KEYSTONE MASONRY SUPPORT SYSTEM

A range of systems suitable for supporting any outer leaf material: brickwork, fairface blockwork, rendered blockwork, cut and reconstituted stone. The systems can be fixed back to reinforced concrete cast-in channel and steel sections.

The Keystone Masonry Support System is an off the shelf product which means the brackets and shelf are interchangeable, allowing greater flexibility for various loading scenarios.

72

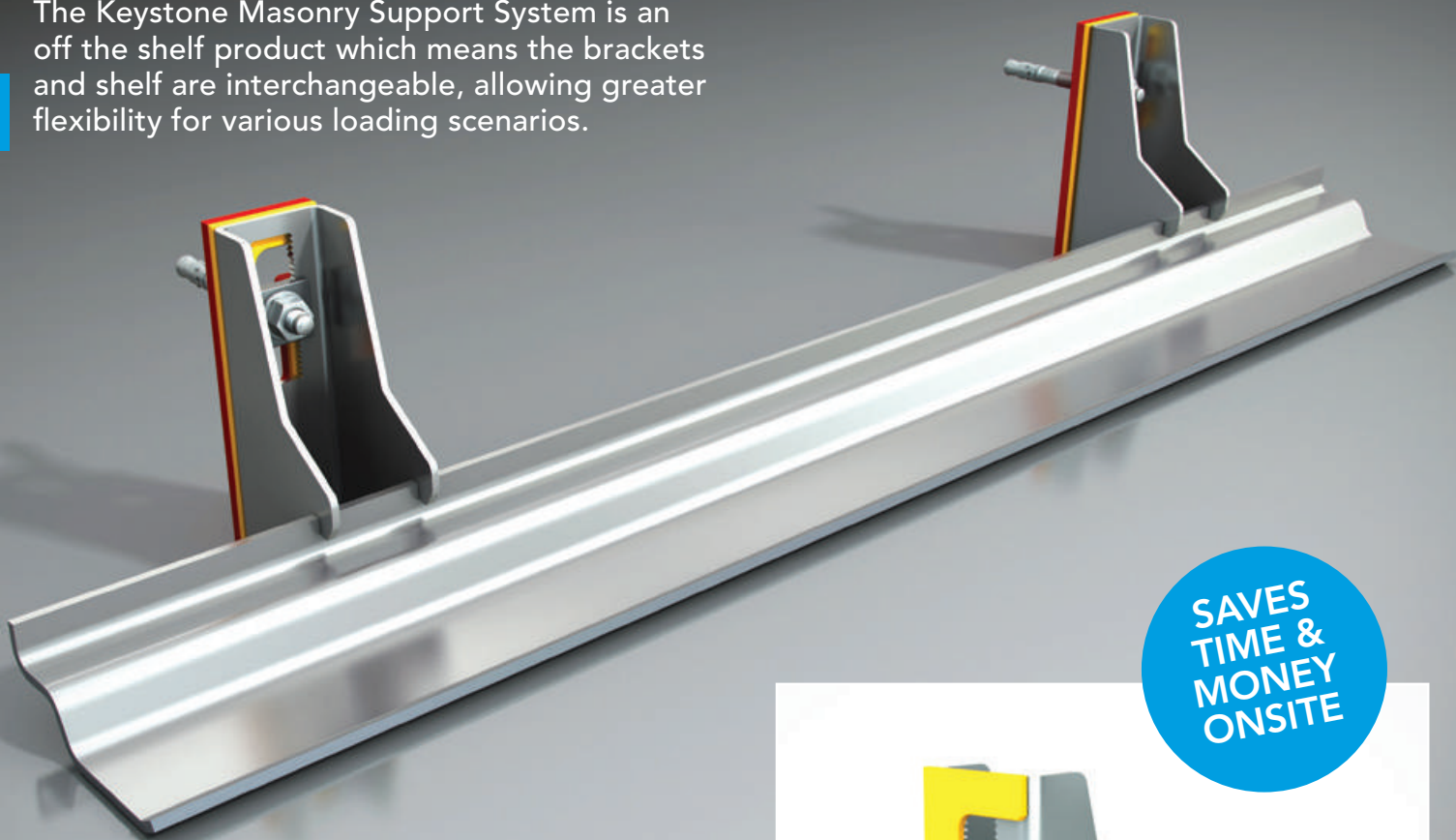

SAVES  
TIME &  
MONEY  
ONSITE

- Cavity sizes range from 70mm-150mm. Larger cavities are available upon request.
- The Masonry Support System provides greater adjustment both vertically and horizontally compared to the traditional welded system.

All enquires please contact :  
[specialprojects@thekeystonegroup.co.uk](mailto:specialprojects@thekeystonegroup.co.uk)





## RB/K LINTEL

For use with integral concrete ring beams. The RB/K type lintel must be bolted to the concrete ring beam at 400mm c/c using M16 anchor bolts.

The RB/K type range can be supplied to facilitate various cavity widths: eg specify RB/K-50, RB/K-70, RB/K-90.



73

### RB/K 50

Manufactured length 150mm increments	600- 1500	1650- 3000	3150- 4800
Height 'h'	200	200	200
Thickness	2.5	2.9	3.2
Total UDL kN/m	7.5	7.5	7.5

### 50-65mm cavity

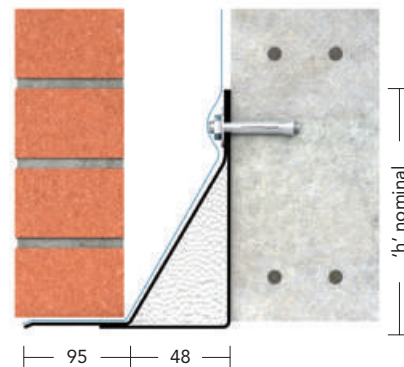

### RB/K W (Specify 75mm or 100mm cavity)

Manufactured length 150mm increments	600- 1500	1650- 2400	2550- 4800
Height 'h'	200	200	200
Thickness	2.5	2.9	3.2
Total UDL kN/m	7.5	7.5	7.5

### Specified cavity width

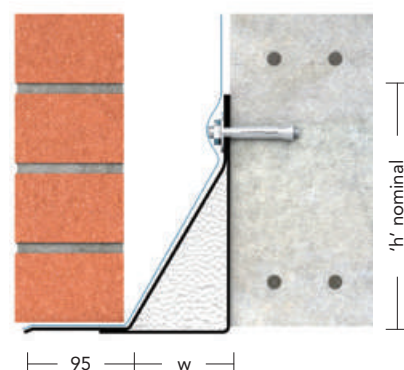

W = cavity width of 75mm or 100mm  
Order RB/K W and specify cavity width

## Windposts

Keystone Windposts span vertically between floors to provide additional lateral support for large panels of brickwork or large panels with openings. Keystone manufacture three types of windposts.



### Stainless steel windposts for a range of loads

74

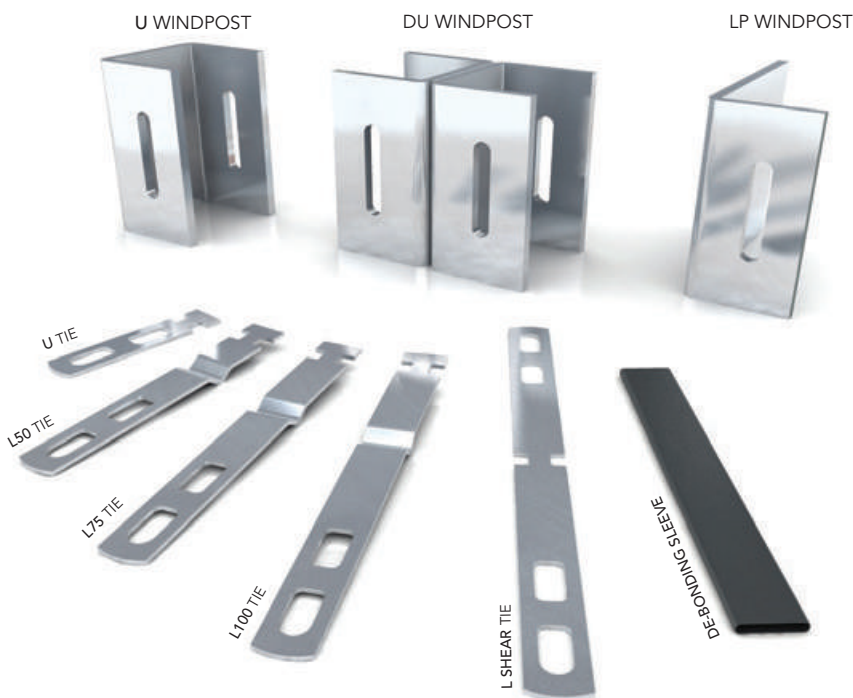

#### U WINDPOST

The U windpost is a channel section designed for standard loading conditions and is installed within the cavity.

#### DU Windpost

The DU windpost is a “back to back” channel section designed for heavier loading conditions and is installed within the cavity.

#### LP Windpost

The LP Windpost is an “L” shaped section designed to suit a range of loading conditions and is built into the inner skin of the cavity wall.

#### Material Specification

Keystone Windposts are manufactured from grade 304 stainless steel.

The Keystone Technical Team will provide full product specification and schedules.

#### Lintel Hotlines

UK - 01283 200 150

N.I - 028 8676 2184

ROI - 048 8676 2184

Fax Back Enquiry Forms are available for download at [www.keystonelintels.com](http://www.keystonelintels.com)

## Windposts

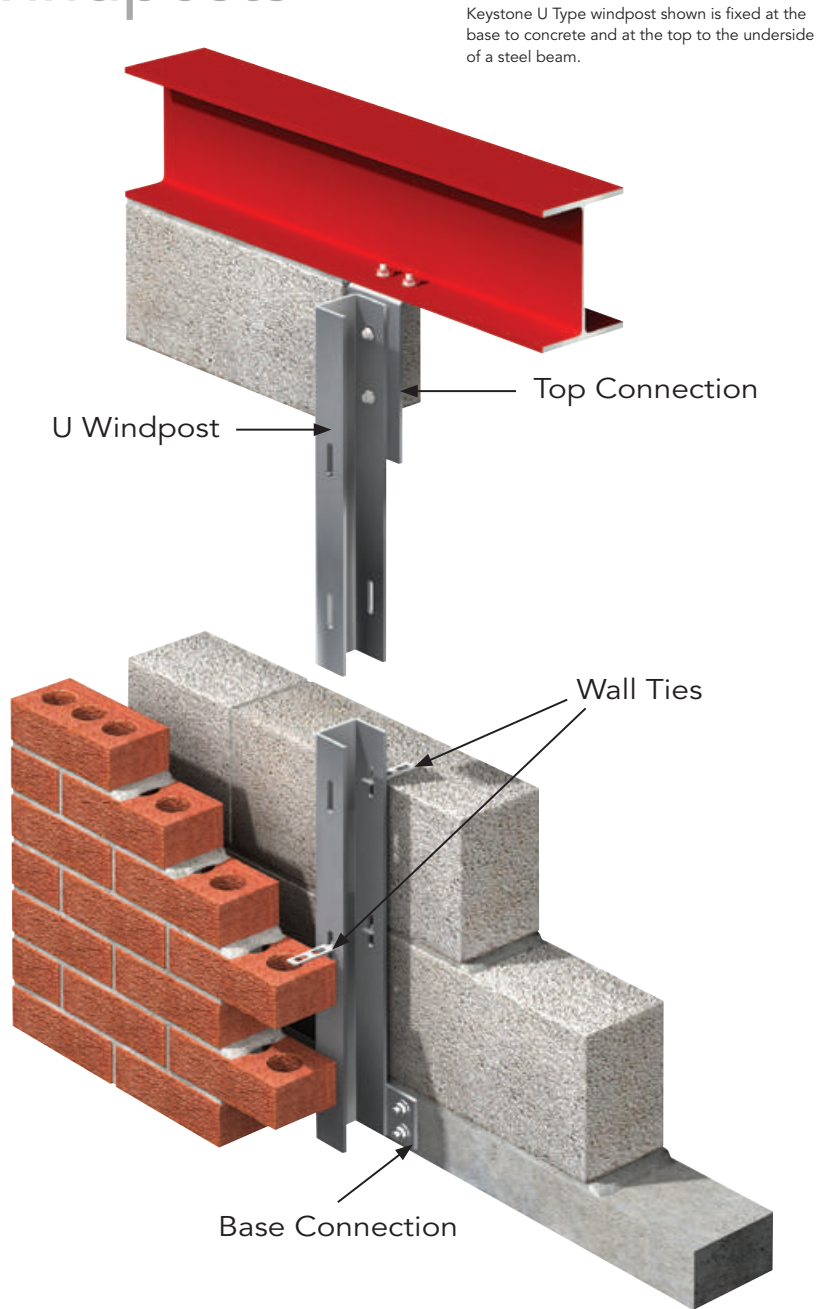

### DU WINDPOST



### U WINDPOST



### LP WINDPOST



### WINDPOST CONNECTIONS & WALL TIES

All Keystone Windposts are supplied with specifically designed base and top connections. They are also supplied with a suitable number of wall-ties which will vary in relation to the post type used and the cavity width. There are five types of wall ties available.

U Tie	For use with U & DU Windposts.
L50	Tie – For use with LP Windposts (50mm cavity).
L75 Tie	For use with LP Windposts (75mm cavity).
L100 Tie	For use with LP Windposts (100mm cavity).
L Shear Tie	For use with LP Windposts.

**Note:** L Shear Tie can be supplied with a de-bonding sleeve if the windpost is positioned at a vertical movement joint.

# Signature Projects

A selection of Keystone's bespoke design projects



## Special Roof Design

Award winning country home with elegant proportions.

### PROJECT DETAILS

Keystone Engineer created an exceptional structural steel roof as well as a two storey bowed lintel frame and two arched lintels for the stone quarters. The steel roof structure spans 19 metres in length, 12 metres wide and has a total height of 2.8 metres.

Before the structure went to site the full steel frame was erected in Keystone's manufacturing facilities to ensure it could be slotted perfectly into place. The frame was then dismantled and delivered to site by Keystone. This magnificent steel roof structure helps make this project a bit more special.

Architect Des Ewing has successfully softened the impact of the sheer size and newness of this dwelling by creating a playful mix of old and new architecture.

The main house is linked to a smaller stone wing by a curved gallery, lending the building a much more organic feel typical of older houses that have spread and extended over time.

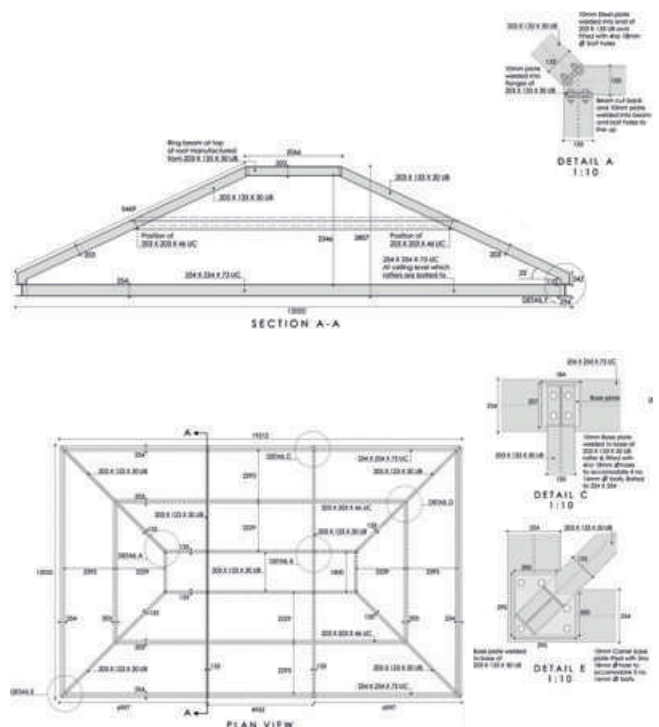

### Special Roof Design

Client :	Private
Architect :	Des Ewing
Contractor :	Seaview Developments
Keystone Engineer :	Chris Patterson

## Stepped Triple Arch

A decorative entrance porch to a new entertainment complex.

### PROJECT DETAILS

Spanning 7.2 metres in length this fully insulated, 400mm wide lintel provides full structural support for the entrance porch. To enhance the overall aesthetics of the bar front, the Keystone Engineer ensured that no steelwork was visible once construction was complete.

The structure also incorporates a steel ladder frame bolted to the vertical support posts. This frame provides a load bearing facility for the decorative wooden framing of the windows and doors.

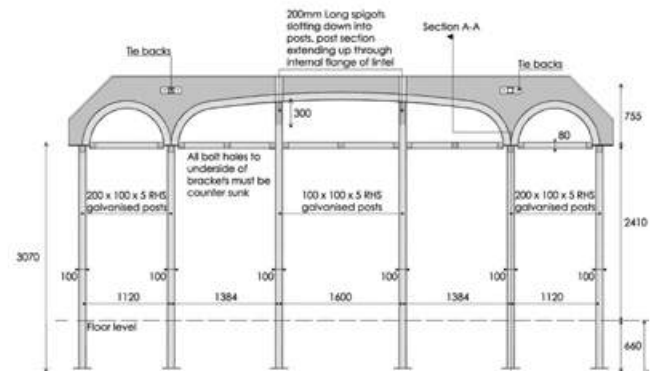

### Stepped Triple Arch Lintel

Client :	M McElroy
Architect :	McCarter Hamill
Contractor :	McElroy
Keystone Engineer :	Chris Patterson

## Glazed Gable Apex Sun Lounge

A key feature in this stunning home in Magherafelt.

### PROJECT DETAILS

Keystone Engineer Paul Graham designed all the steel lintels for this property and was available onsite to assist the architect and builders. He also had to take into consideration the unusual wall construction which consisted of a double cavity of 100mm with two sections of block and one section of brick.

As well as the large Apex sun lounge, many other lintels were used to make this a beautiful family home, including a large 6m wide Arch lintel at the front of the property, a large double storey corner lintel and a ring beam corner lintel at the rear of the property.

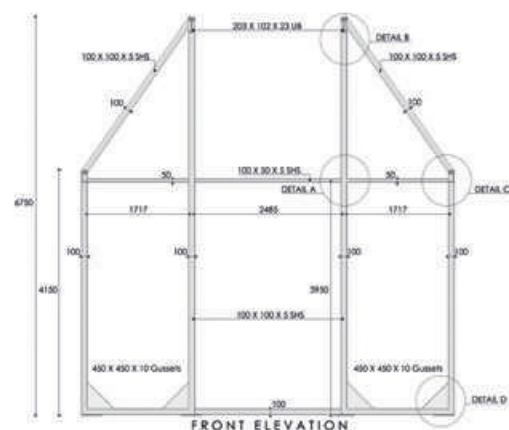

### Glazed Gable Apex Sun Lounge

Client :	Private House
Architect :	GM Design
Contractor :	Higgins Construction
Keystone Engineer :	Paul Graham

## Octagonal Portal Frame

Designed to cater for exclusive wedding ceremonies.

### PROJECT DETAILS

Measuring 16 metres in length, with the main vaulted ceiling spanning 9.7 metres, this deluxe private wedding venue combines modern open space with elegant style.

The Octagonal Portal Frame was manufactured using a variety of steel beams, columns and sections bolted together to create a structural support for the building.

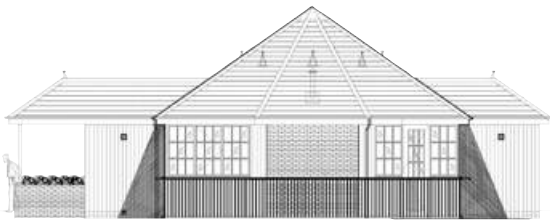

### Octagonal Portal Frame

Client : Galgorm Manor Hotel

Architect : RPP Architects

Contractor : -

Keystone Engineer : Kyle Alexander

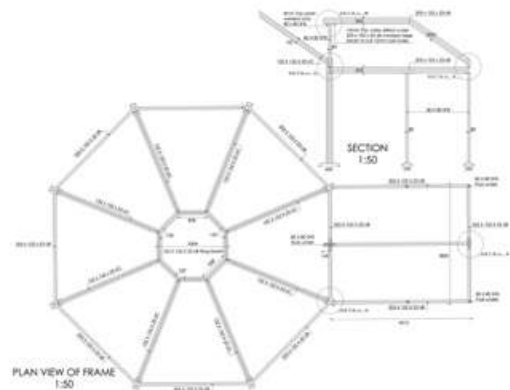

## Glazed Gable Apex

Including cantilevered balcony.

### PROJECT DETAILS

Televised in the BBC's "House of the Year", this family home is a quintessential example of Keystone's innovative engineering. Working closely with Architect - Andrew Coulter, Keystone Engineer - Chris Patterson, detailed the unique two storey glazed gable apex with a cantilevered balcony, two story corner lintels and half apex corner lintels.

The apex portal frame is 8.5 metres high and spans 5 metres wide. Keystone also supplied a ridgebeam to bolt back from the apex of the gable frame to provide support for the vaulted ceiling. This diversity of steel framing was created using a combination of structural steel sections and supports.

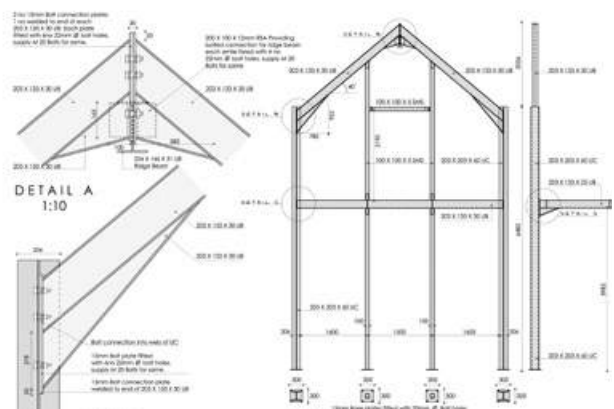

### Glazed Gable Apex with Balcony

Client : Private

Architect : Andrew Coulter Architects

Contractor : H&J Martin

Keystone Engineer : Chris Patterson

## Signature Projects

### Continuous Heavy Duty Arches

Agricultural, Food & Bio-Sciences Building.

#### PROJECT DETAILS

The original arches had been blocked up and supported by concrete lintels. The client wanted to reveal the traditional arches of the building and needed a support structure for the brickwork above. Due to the deterioration of the existing brickwork the contractor required further structural support and contacted the Keystone Technical Team to discuss a possible solution.

Steel pins were placed through the original stonework and supported from below. This suspended the upper floor of the building whilst the deteriorated bottom floor stonework was removed. Keystone posts were then put in place and the arches bolted on top. The original brick and stone were then replaced and the structural pins removed leaving Keystone's heavy duty arches to carry the load.

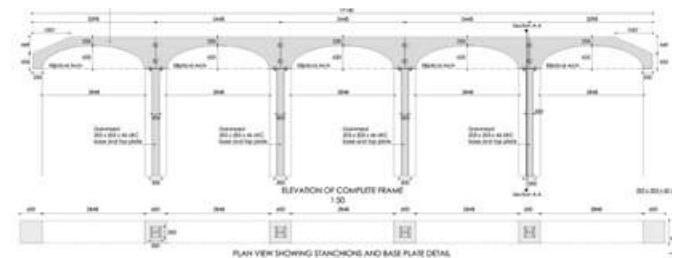

#### Continuous Heavy Duty Arches

Client : Agri-Foods & Bio-Sciences

Architect : Todd Architects

Contractor : H&J Martin

Keystone Engineer : Chris Patterson

### Structural Apex Frame

A double height apex window frame.

#### PROJECT DETAILS

G.M. Design Architects called on Keystone's creative lintel department to detail this unique lintel. Keystone Engineer Kyle Alexander, developed the structural steel framework to support the glazed gable apex and the roof structure above the balcony terrace.

Spanning 8 metres long and 4.5 metres high this complex steel frame was constructed from a range of steel sections.

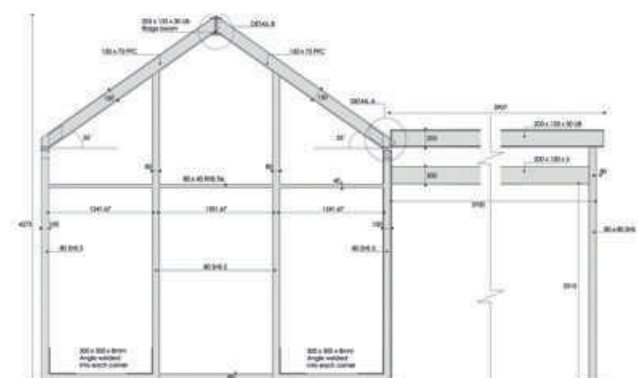

#### Structural Apex Frame

Client : Private

Architect : GM Design

Contractor : Glebeview Builders

Keystone Engineer : Kyle Alexander

## Stepped Parabolic Corner

A stepped corner lintel with a parabolic arch.

### PROJECT DETAILS

For this project, Keystone Engineer - Kyle Alexander designed a stepped corner lintel with a parabolic arch to suspend over 1 tonne of stone from the outer steel shelf. The lintel was designed to ensure that no steelwork was visible.

This system works by drilling holes into the outer steel shelf. Expansion plugs are then placed into the hanging sandstone and are bolted from above through the holes in the steel shelf. In addition to supporting the load of the hanging stone, the fully insulated lintel carries a 500mm wide wall structure above.

Spanning 7 metres along the front face and returning a further 3 metres at the corner, this special lintel is a prime example of how Keystone lintels can adapt to the client's brief.

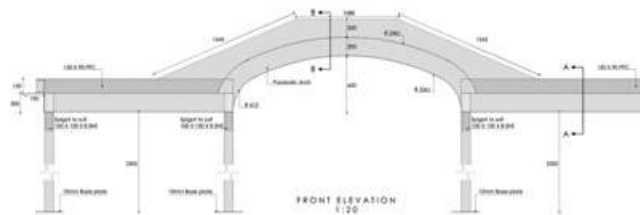

### Stepped Parabolic Corner

Client :	Private
Architect :	Diamond Architecture
Contractor :	Self-build
Keystone Engineer :	Kyle Alexander

## Angled Apex Frames

Private house, Ballykelly.

### PROJECT DETAILS

The architect liaised with a Keystone engineer who had to take precise measurements onsite to create two very different but equally stunning Angled Apex Frames.

The Angled Apex Frame measured 4.8 metres high and 4 metres wide and included fully insulated 180mm box sections. The frames had to be delivered to site in two sections, these were bolted onsite via pre-drilled access holes.

The homeowner wanted to create a feature of not only the lintels used but also on the finishes, deciding on a natural stone finish for the outside of the house. Due to the stone finish Keystone had to include welded gusset plates to carry the stonework on the outer leaf and to resist against sliding.

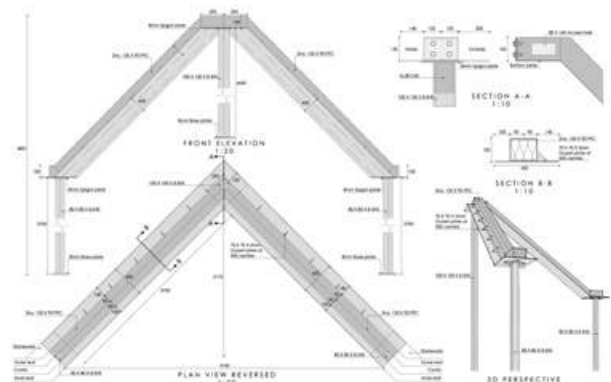

### Angled Apex Frames

Client :	Private
Architect :	Hamilton Architects
Contractor :	-
Keystone Engineer :	Kyle Alexander



## Triple Bow Sun Lounge

An elegant feature for a prestigious project.

### PROJECT DETAILS

Due to the precise onsite measurements taken by Keystone's Engineer, the full steel structure could be slotted perfectly into place. Two parallel flange channels were rolled 'back to back' to create the 3.3 metre radius bows.

A steel plate which was curved on plan, was welded to the channels to facilitate blockwork on the outer flange. Two additional smaller bows with a radius of 1.25 metres create a lantern effect in the valuted ceiling of the sun lounge.

Spanning 6.5 metres in length with a total height of 4.7 metres this steel frame provides an elegant feature to this prestigious project.

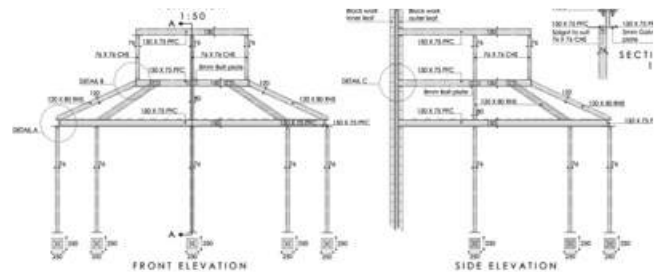

### Continuous Heavy Duty Arches

Client :	Private
Architect :	GM Design
Contractor :	J & D Mooney
Keystone Engineer :	Odhran McGoldrick

## Cantilevered Walkway

Retrofit balcony and walkway.

### PROJECT DETAILS

The steel structure was manufactured from a mixture of universal beams, square and circular hollow sections bolted to a concrete ring-beam in the existing building. Specially designed fin plate bolted connections secured the walkway to Keystone galvanized steel posts. The outer flange incorporates an extended leaf to facilitate 300mm stonework.

The most notable feature of this project is that, the Keystone engineers measured, designed and detailed every aspect of the walkway. This retrofit walkway proved to be a perfect example of how Keystone's team can be relied upon to design, manufacture and deliver onsite to the clients exact requirements.

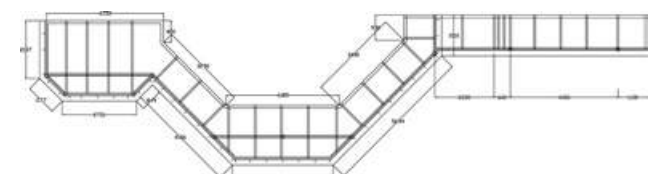

### Structural Apex Frame

Client :	Private
Architect :	-
Contractor :	John Ladden
Keystone Engineer :	Odhran McGoldrick

## Venetian Arch Square Bay

Private house, Derbyshire.

### PROJECT DETAILS

Contractor Hardwick Coleman and Whotten came to Keystone Lintels looking for a solution to form the spectacular entrance porch feature for this project in Derbyshire. Keystone Engineer Andy Sharlot had a meeting onsite with the contractor and the reconstituted stone manufacturer to ensure the lintel and the stone would fit together. Andy then designed a bay with a full arch to each side leg and a Venetian arch to the front. The bay was designed to carry a full storey constructed from a 300mm wide cavity wall above the lintel and to support 580mm wide stone underneath the lintel. The lintel was then designed, manufactured and delivered to site and the lintel went up without a problem and all the stone fitted first time. Keystone proved that when something bespoke is required they can manufacture to the exact requirements.

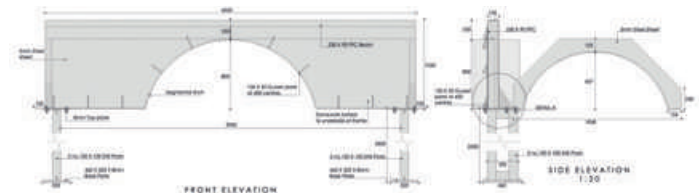

### Stepped Parabolic Corner

Client :	Private
Architect :	Montague Architects
Contractor :	Hardwick Coleman & Whotton
Keystone Engineer :	Andy Sharlot

## Special Arch Lintels & Colonnade Supports

Complex lintel solutions for a new build mansion

### PROJECT DETAILS

Updown court, a neo classic georgian style home designed by US architects John B Scholz, provided enormous opportunities for creative lintel design. Keystone designed and manufactured hundreds of special arch lintels and colonnade supports throughout this magnificent mansion. We also supplied numerous standard, heavy duty and extra heavy duty straight lintels.



### Special Arch Lintels & Colonnade Supports

Client :	Private
Architect :	John B Scholz
Contractor :	-

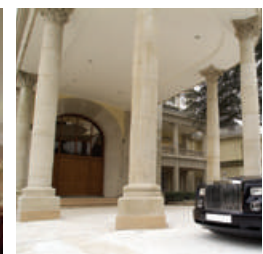
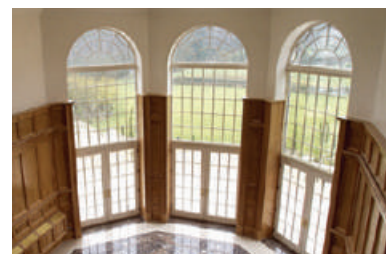

# Cavity Trays

## ROBUST AND COST EFFECTIVE CAVITY TRAY SYSTEM

The Keystone Cavity Tray is a lightweight, simple to install and long-lasting solution to preventing dampness from penetrating below the roof line.



RIDGE TRAY

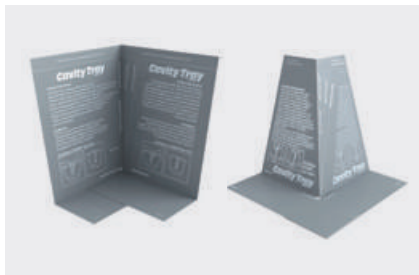

INTERNAL CORNER TRAY

EXTERNAL CORNER TRAY



CATCHMENT TRAY



RIGHT HAND TRAY



LEFT HAND TRAY



REFURBISHMENT TRAY

### UNIQUE PRODUCTS WITH OUTSTANDING BENEFITS

Flexible: Three sizes cover all roof pitches, cavity widths up to 100mm and building materials.

- Off-the-shelf: Pre-creased, flat-packed and easily hand folded onsite.
- Robust: Impact, tear and abuse resistant to last the lifetime of your building.
- Compliant: Meets all current Building Regulations and NHBC requirements.
- Economic: The most cost-effective Cavity Tray system available.
- Durability: Resistant to acid, alkali and sulphate.

# Other products available in the range



Standard Lintels



Special Lintels



Sun Lounge Lintels



Brick Slip Feature Lintels



Hi-therm+



Masonry Supports



Wind Posts



Cavity Trays



Keylite



Smartroof



GRP Components



Loft Ladders

**GB Sales & Service**  
**KEYSTONE - SWADLINCOTE**  
Ryder Close, Cadley Hill Industrial Estate  
Swadlincote, South Derbyshire DE11 9EU

**UK: 01283 200 150**  
**F: 01283 223 352**  
**Email: info@keystonelintelsuk.com**

**NI/ROI Sales & Service**  
**KEYSTONE - IRELAND**  
Ballyreagh Industrial Estate,  
Cookstown Co. Tyrone BT80 9DG

**NI: 028 8676 2184**  
**F: 028 8676 1011**  
**Email: info@keystonelintels.co.uk**

**ROI: 048 8676 2184**  
**F: 048 8676 1011**  
**Email: info@keystonelintels.ie**

[www.keystonelintels.com](http://www.keystonelintels.com)

